

# MultiGips

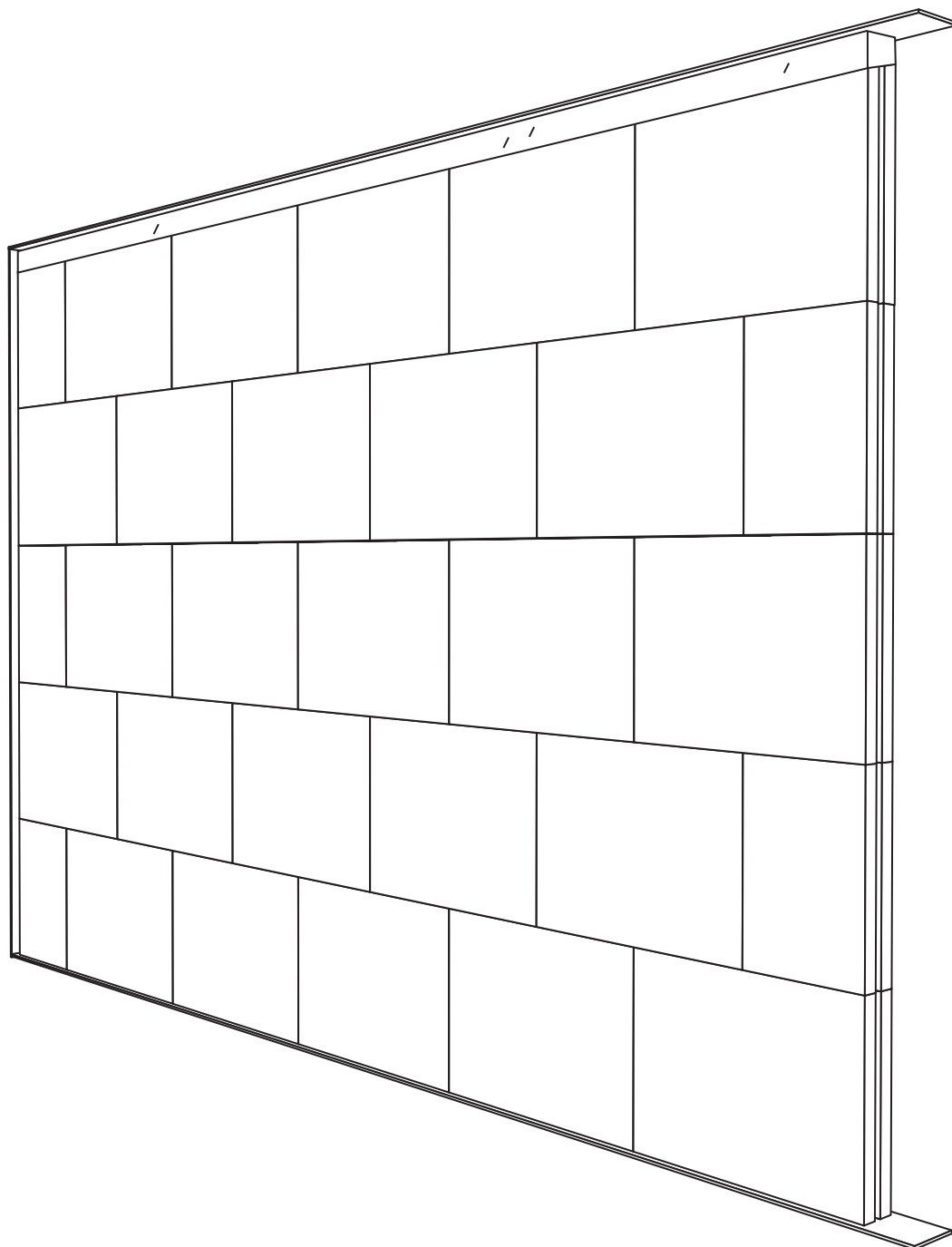

## **Gips-Wandbauplatten**

Gypsum blocks  
Gipsblokken  
Płyty gipsowe

## **Nichttragende innere Trennwände**

Non-load bearing partition walls  
Niet-dragende binnenwanden  
System ścian działowych



Gipsweiß

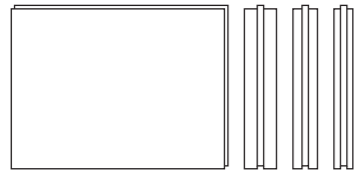

M100  
M80  
M60

Rötlich

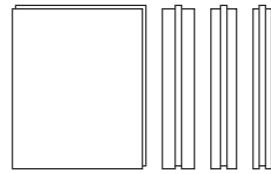

D100-R50  
D100-Rmax  
D80-Rmax  
D60-Rmax  
  
D100-R48

Bläulich

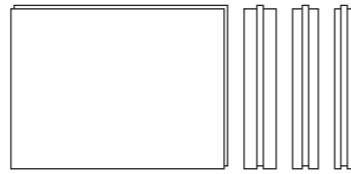

MH100    DH100-Rmax  
MH80     DH80-Rmax  
MH60     DH60-Rmax

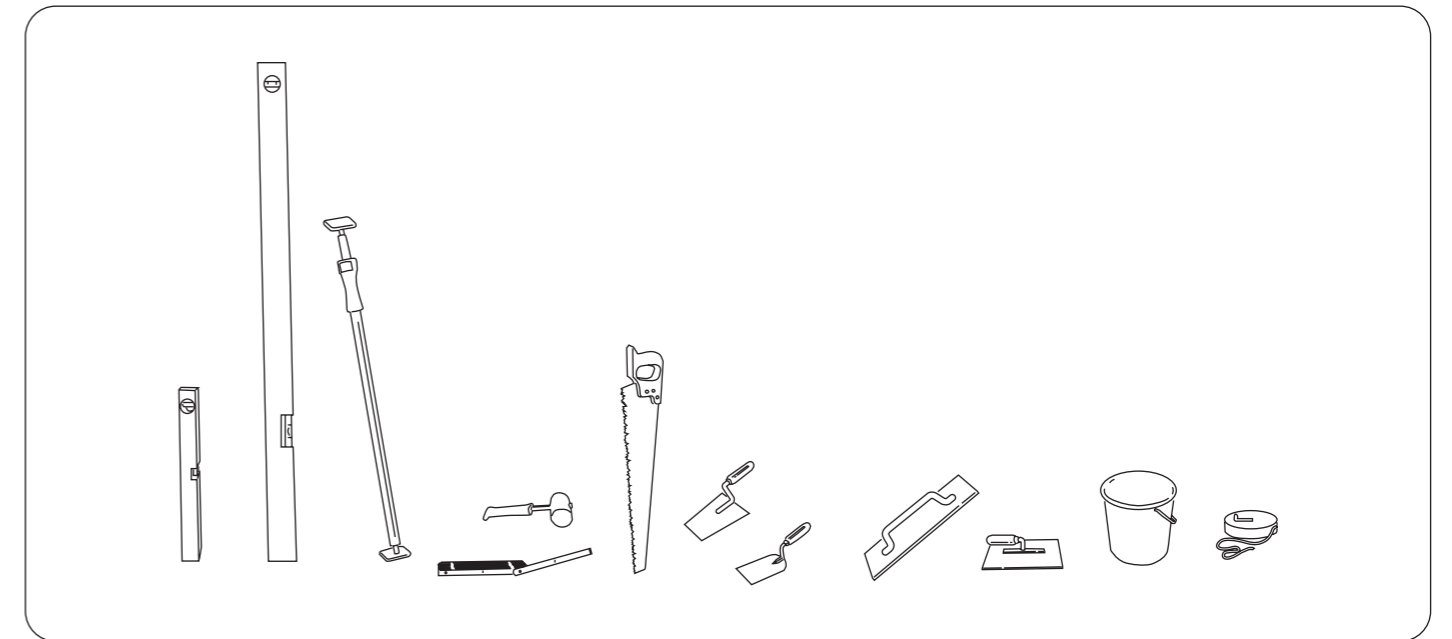

Alternativ

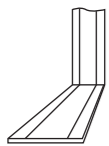

AkustikPro 120-3  
AkustikPro 120-3 sk

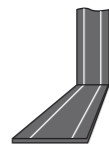

AkustikBit 1000

Alternativ bei  
Brandschutz

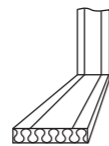

Mineralwolle

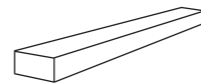

HydroSocket

1 m<sup>2</sup> → 1,3 m

1 m<sup>2</sup> → 0,4 m

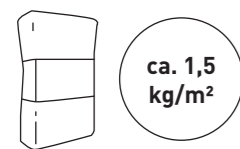
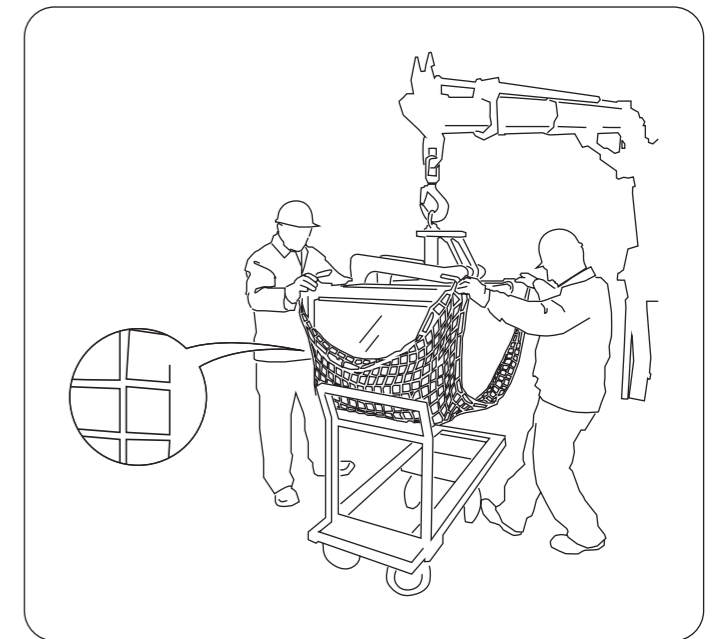
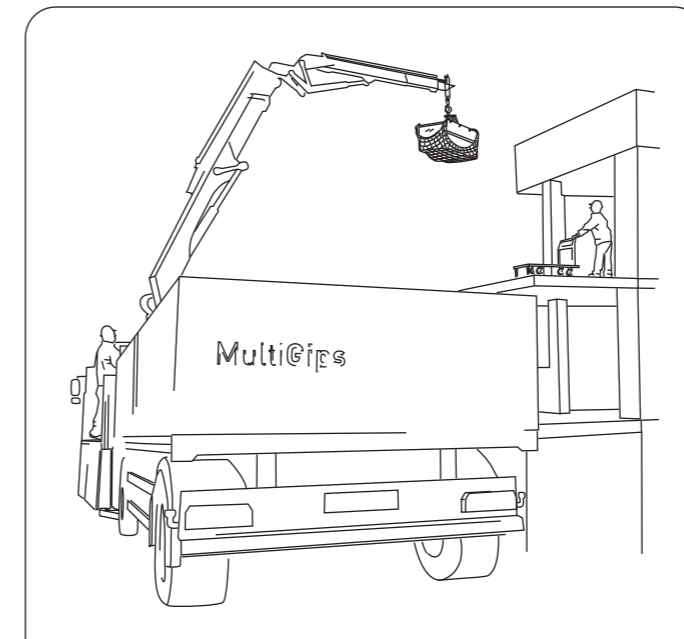

Kleber  
ClassicWeiss 90



Kleber  
Hydro 90

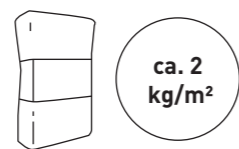

Kleber  
SuperWeiss 120



Kleber  
SuperWeiss 200



Alternativ

Alternativ

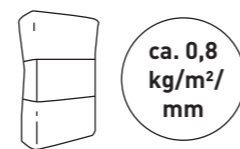

FG 70 Füll- und  
Zargengips



FG 700 Füllgips  
Spezial



FG 70-B Füll-  
und Zargengips



SG 90 Uni  
Flächenspachtel

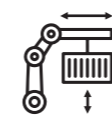

(l)	14 m	18 m	22 m
(h)	≤ 9 m	≤ 15,5 m	≤ 17,5 m



(b) > 0,85 m    (h) > 1,45 m



YouTube

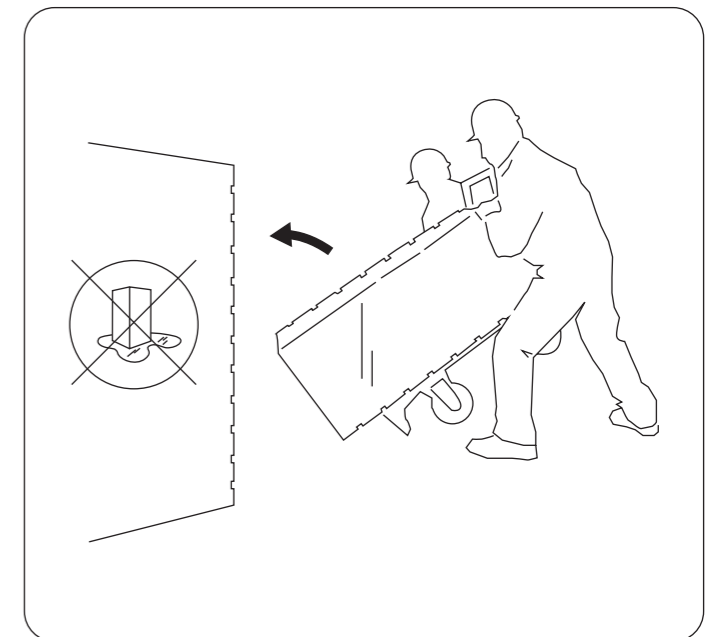

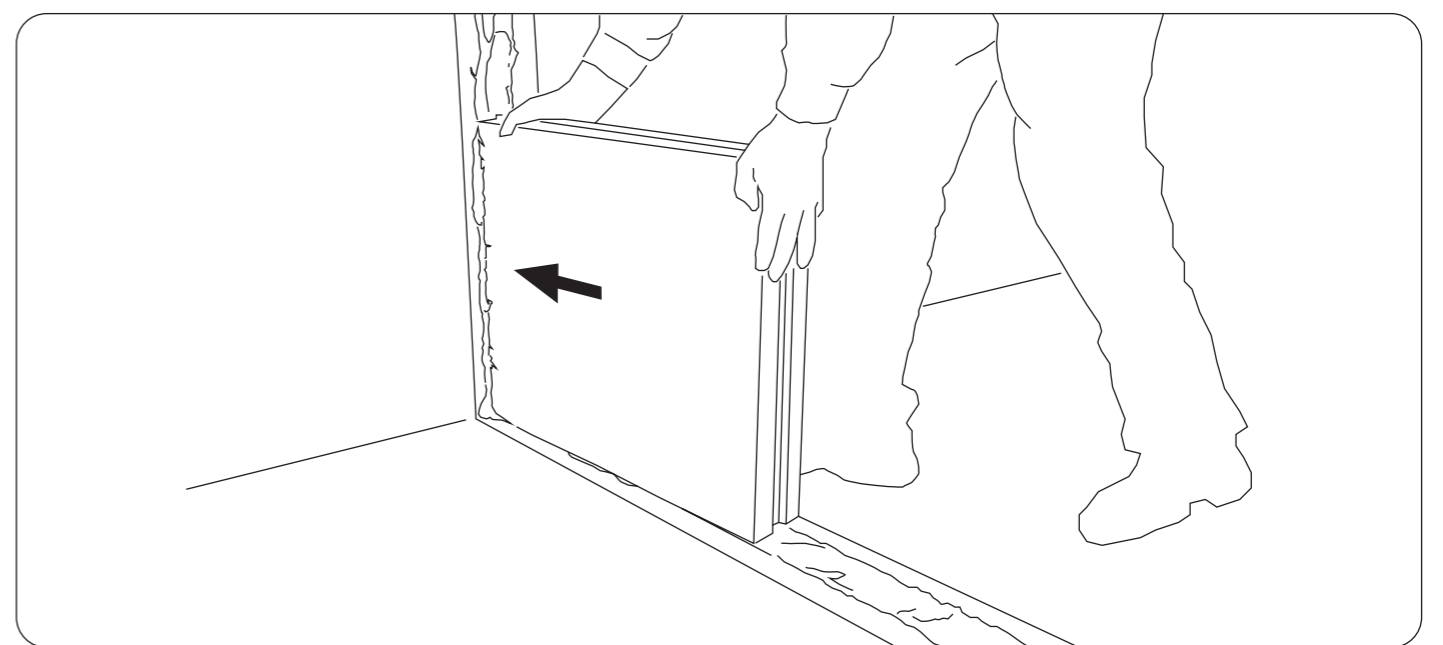
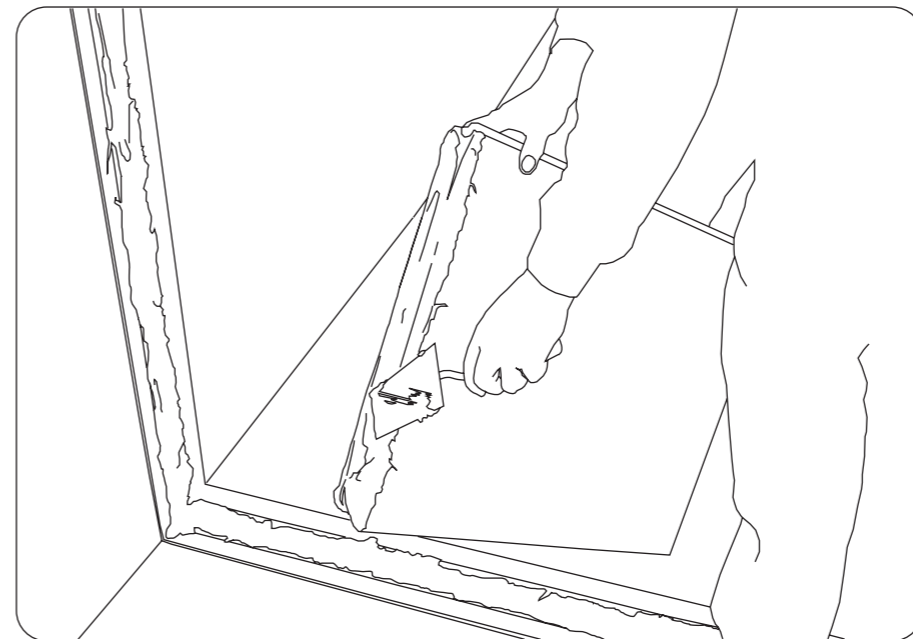
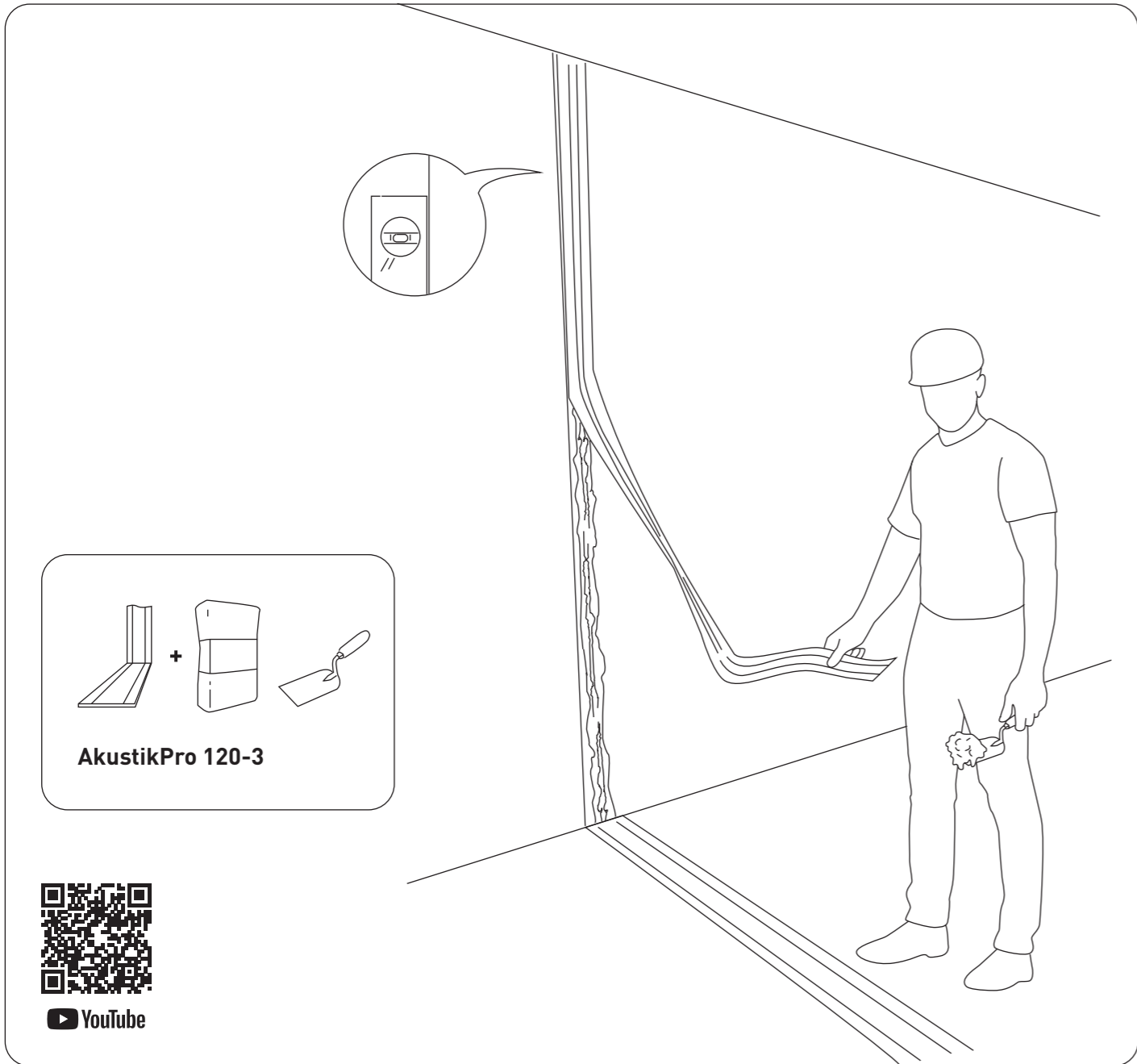
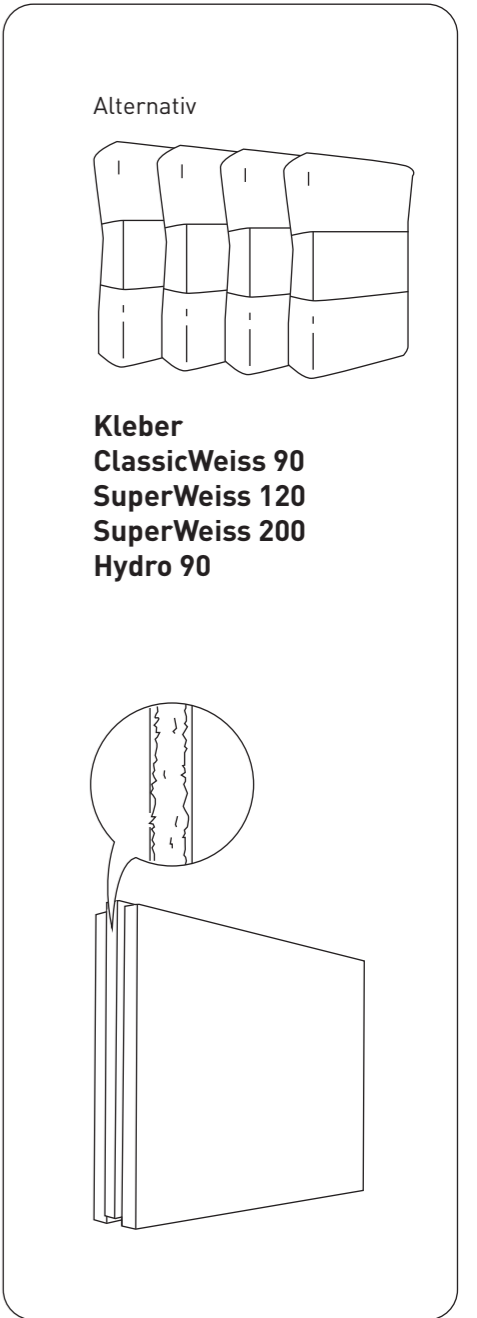
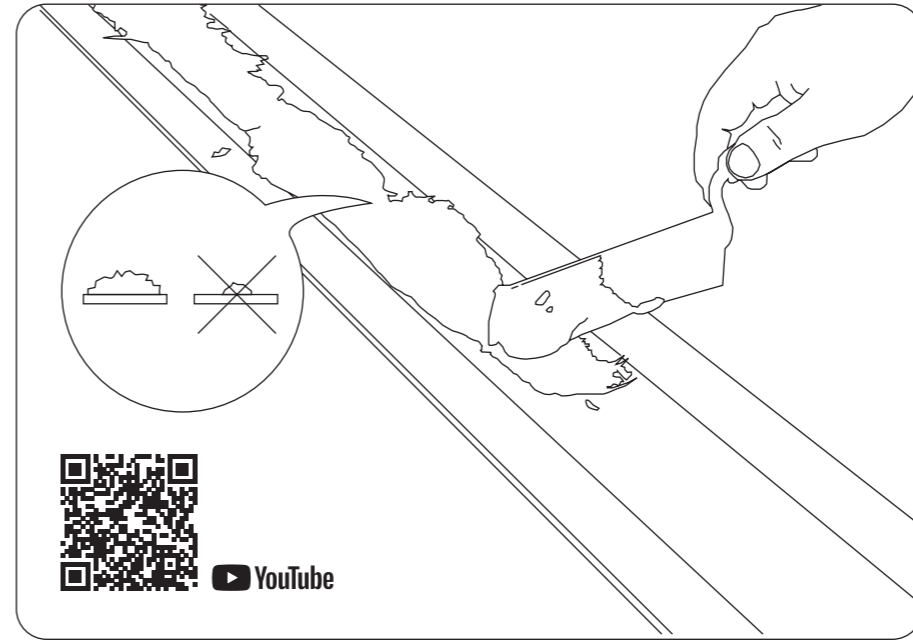
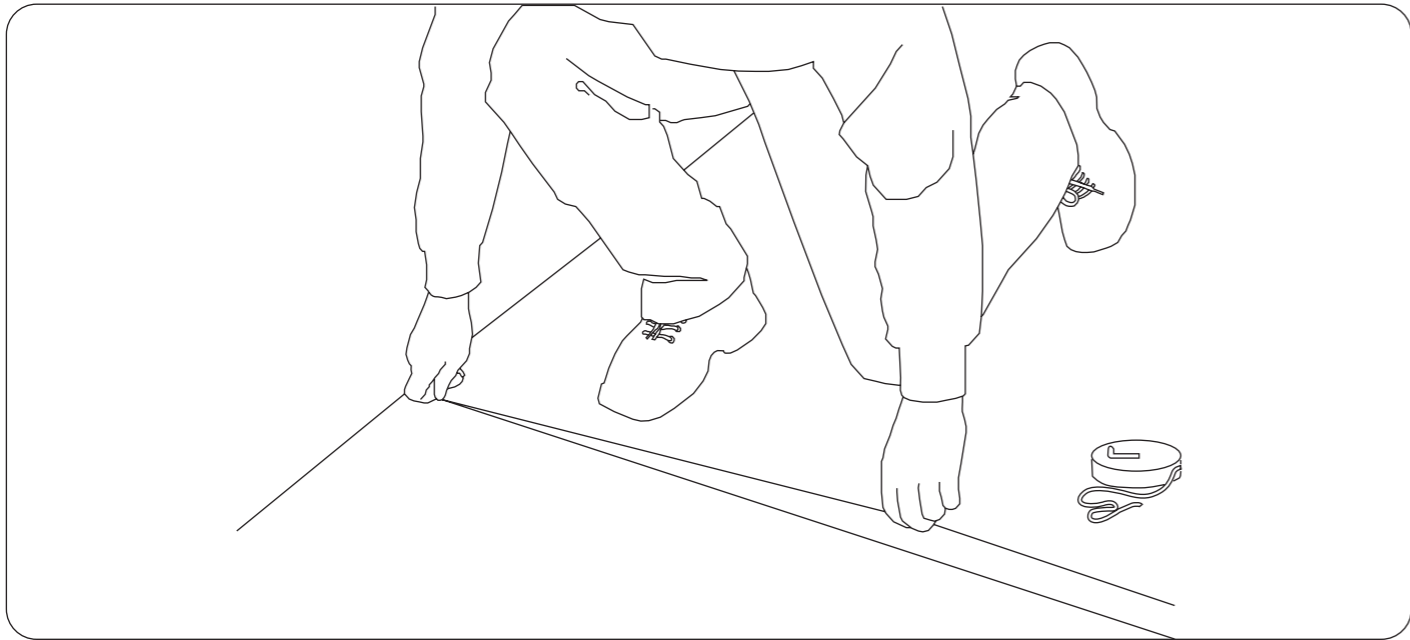

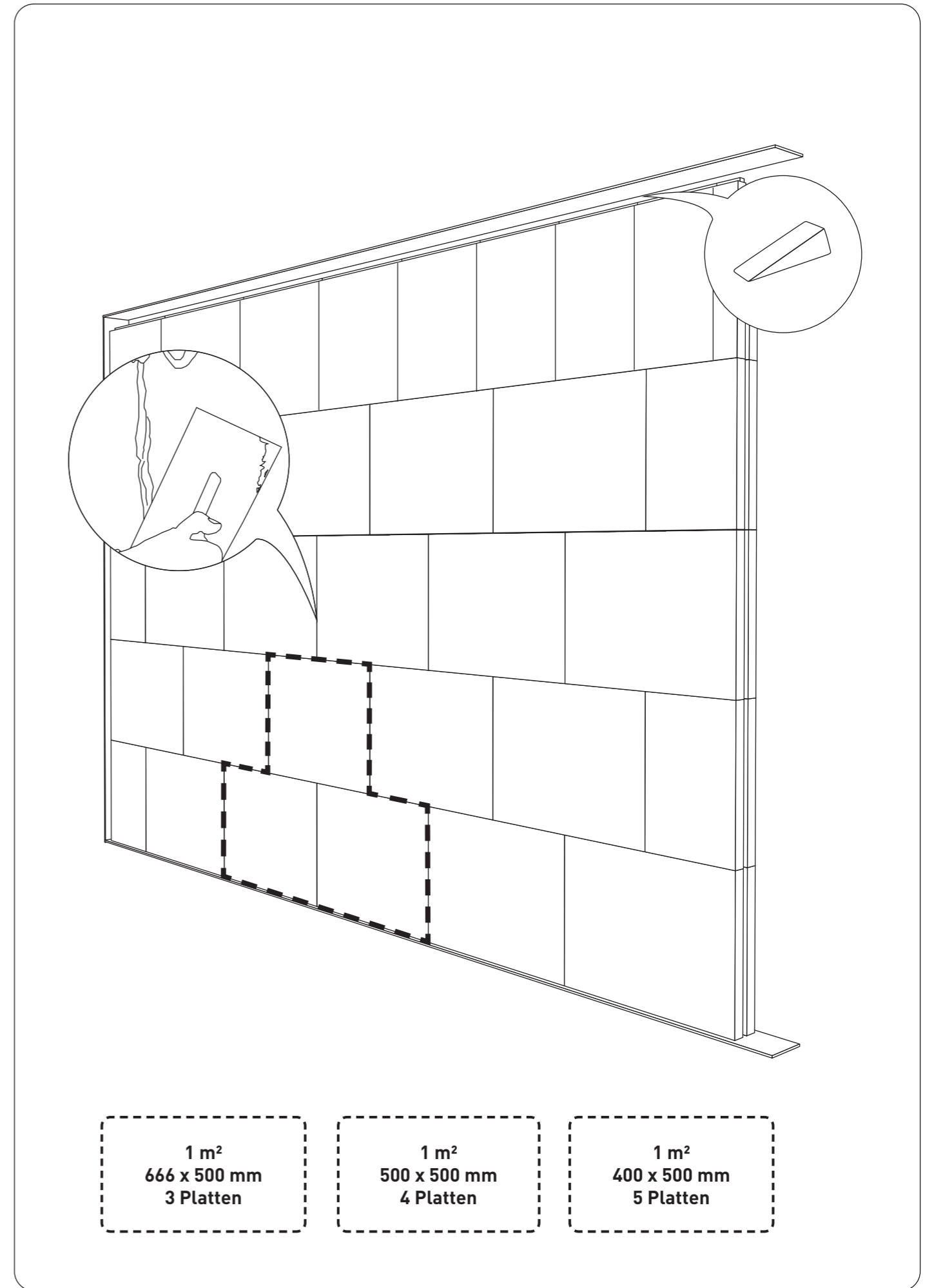
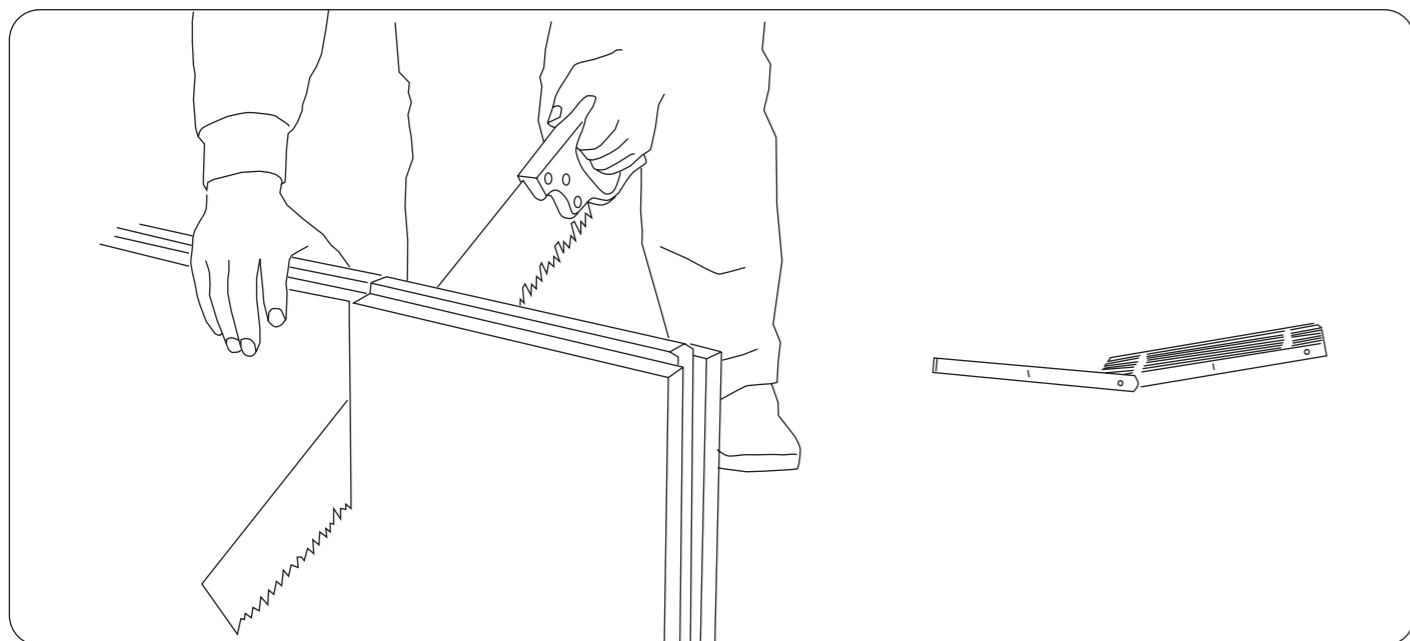
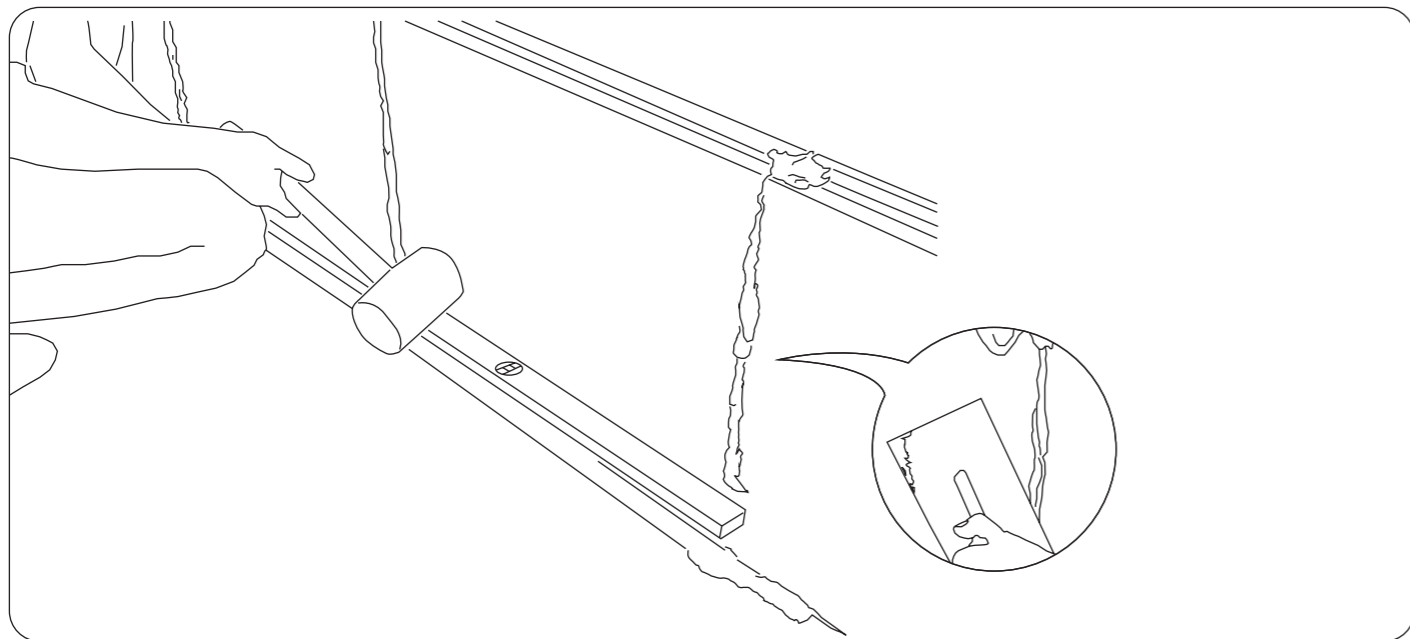
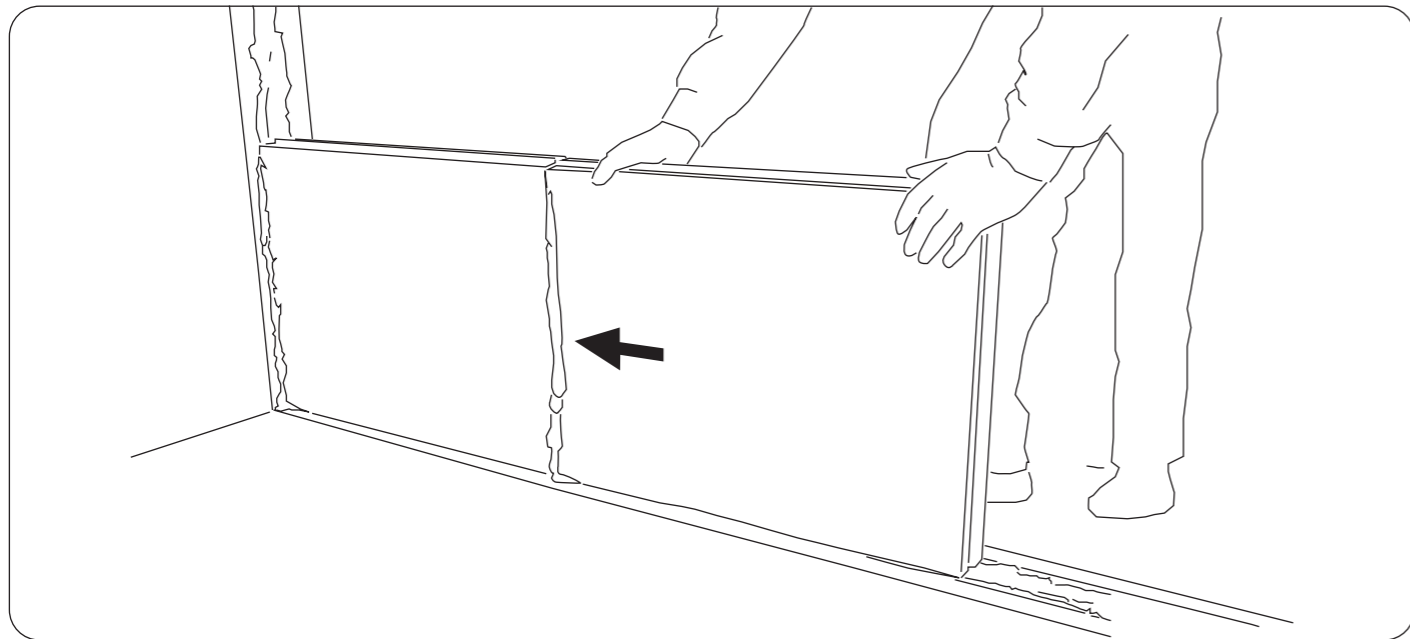

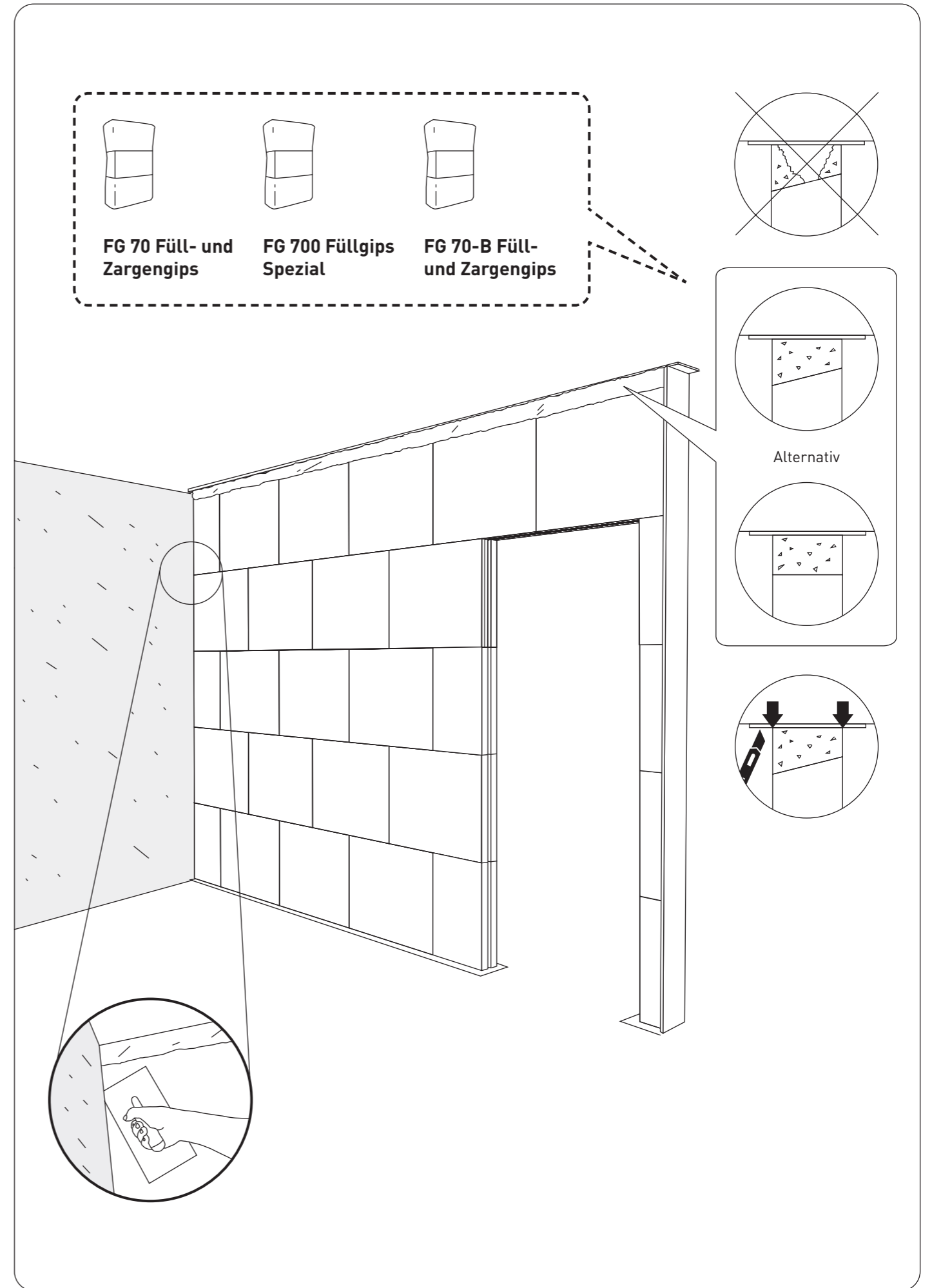
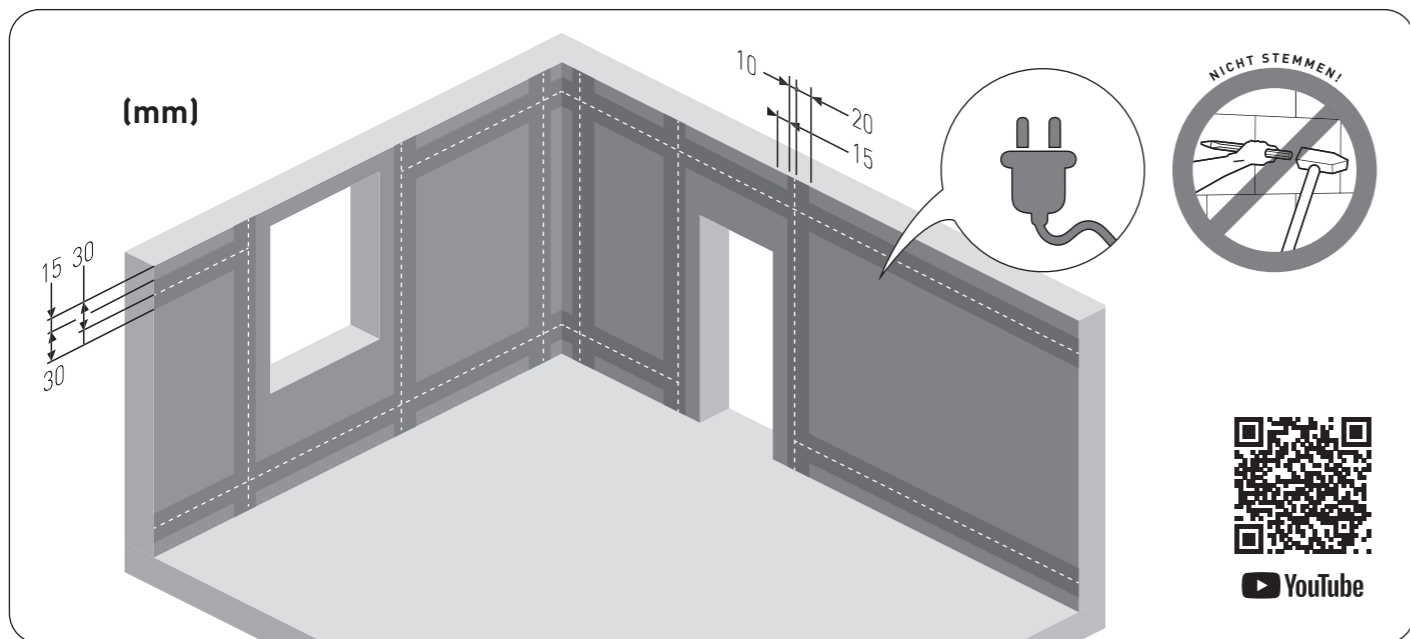
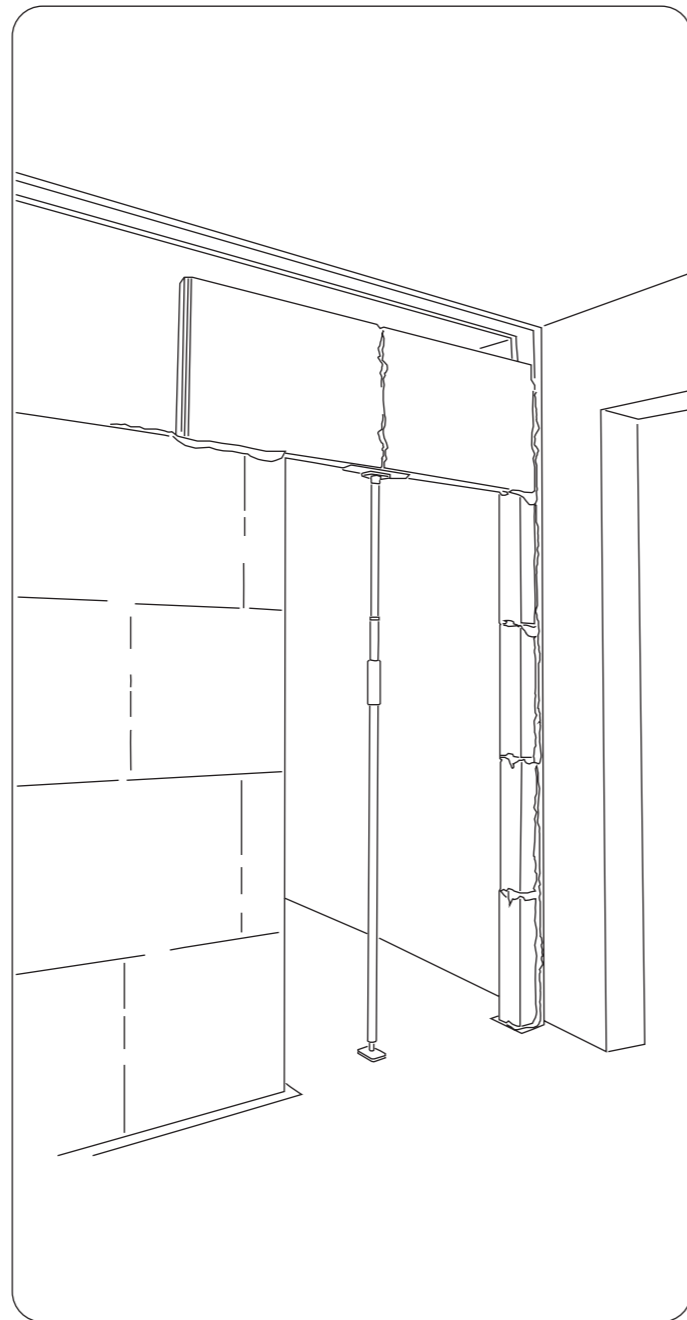
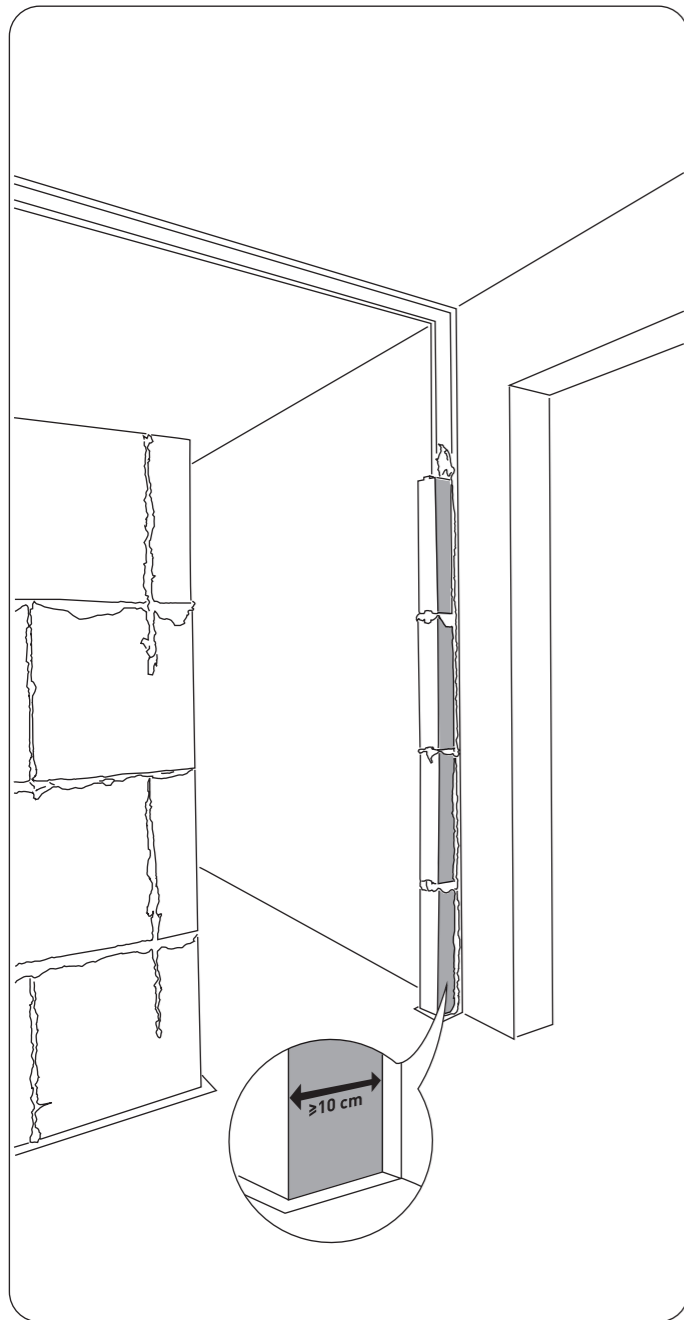

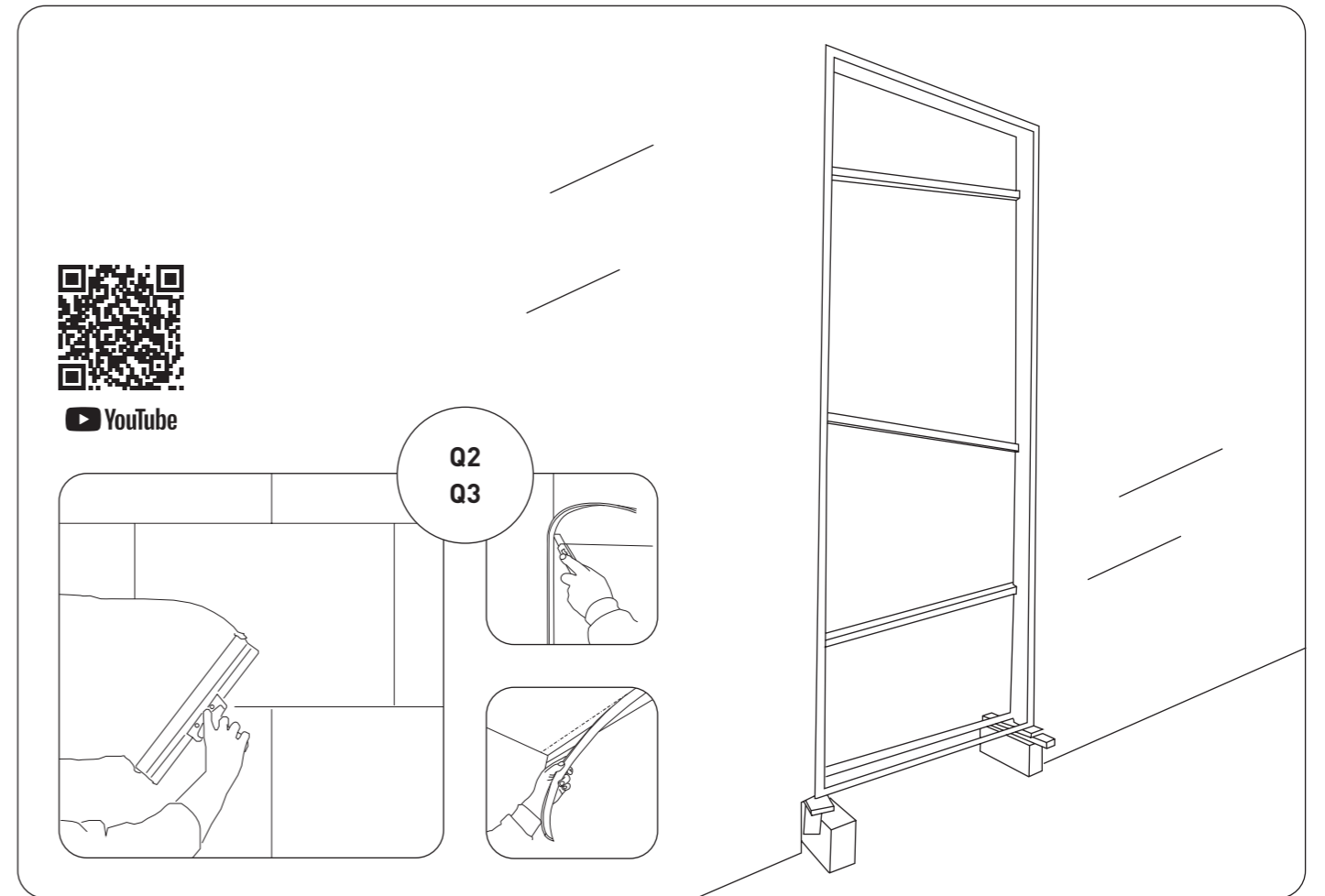
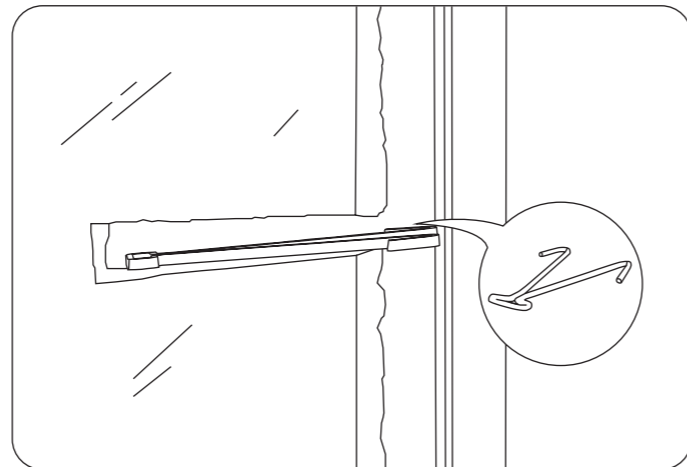
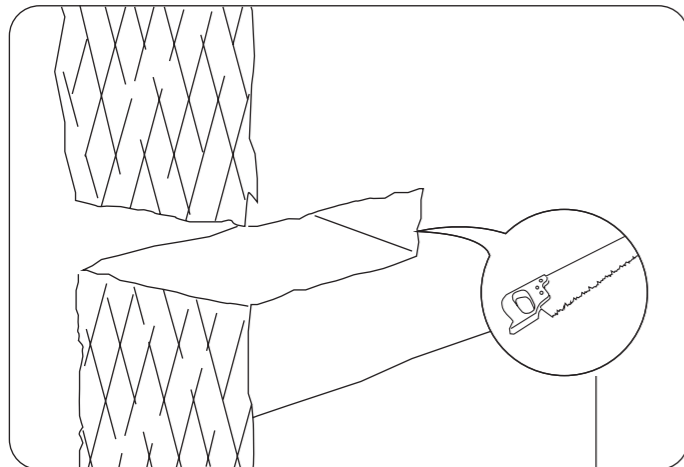
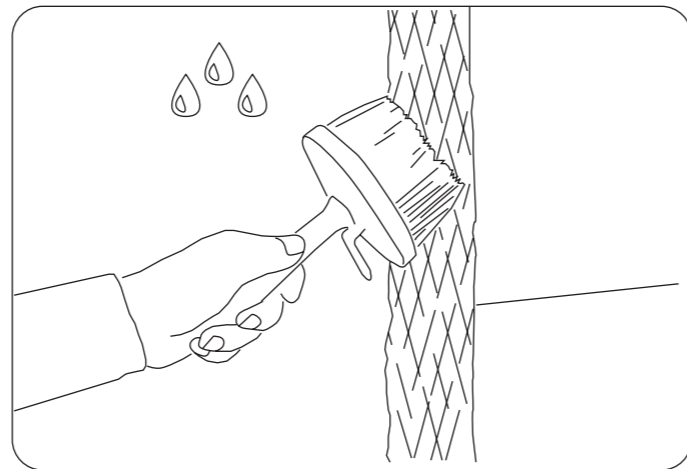
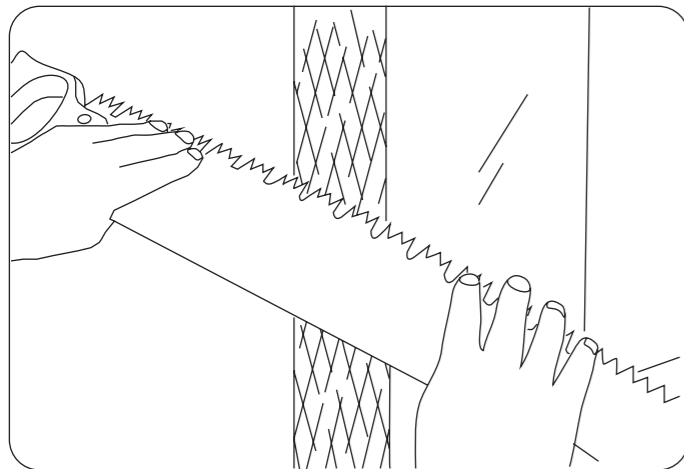
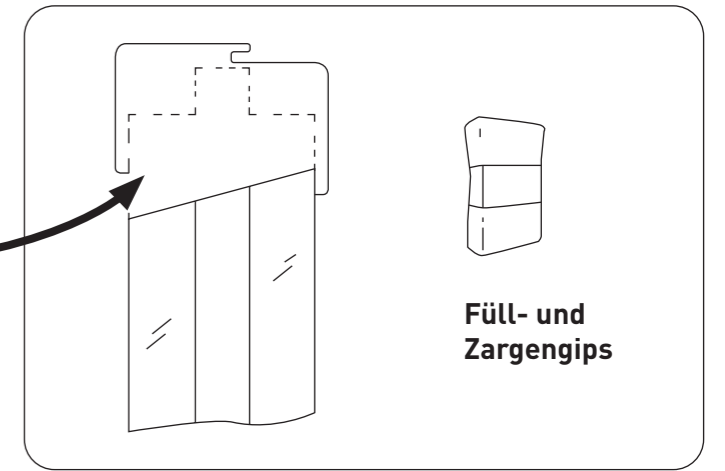
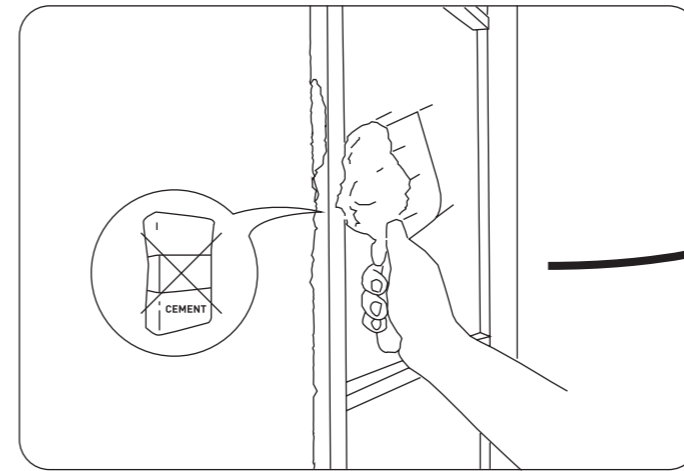
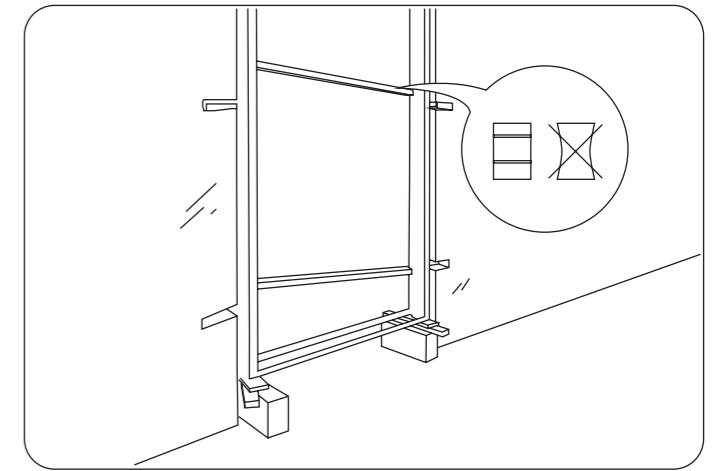
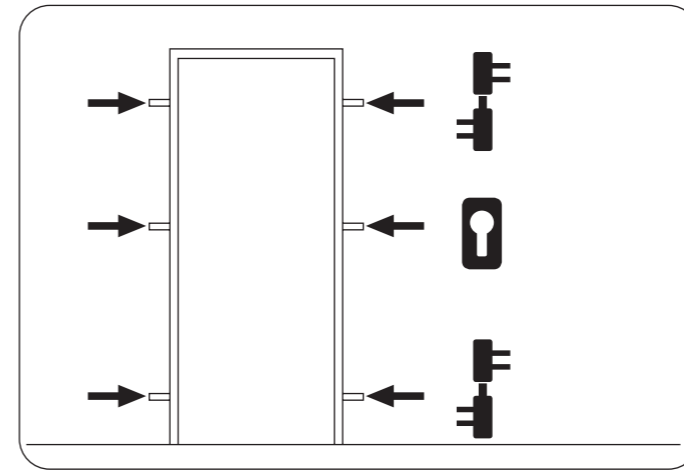
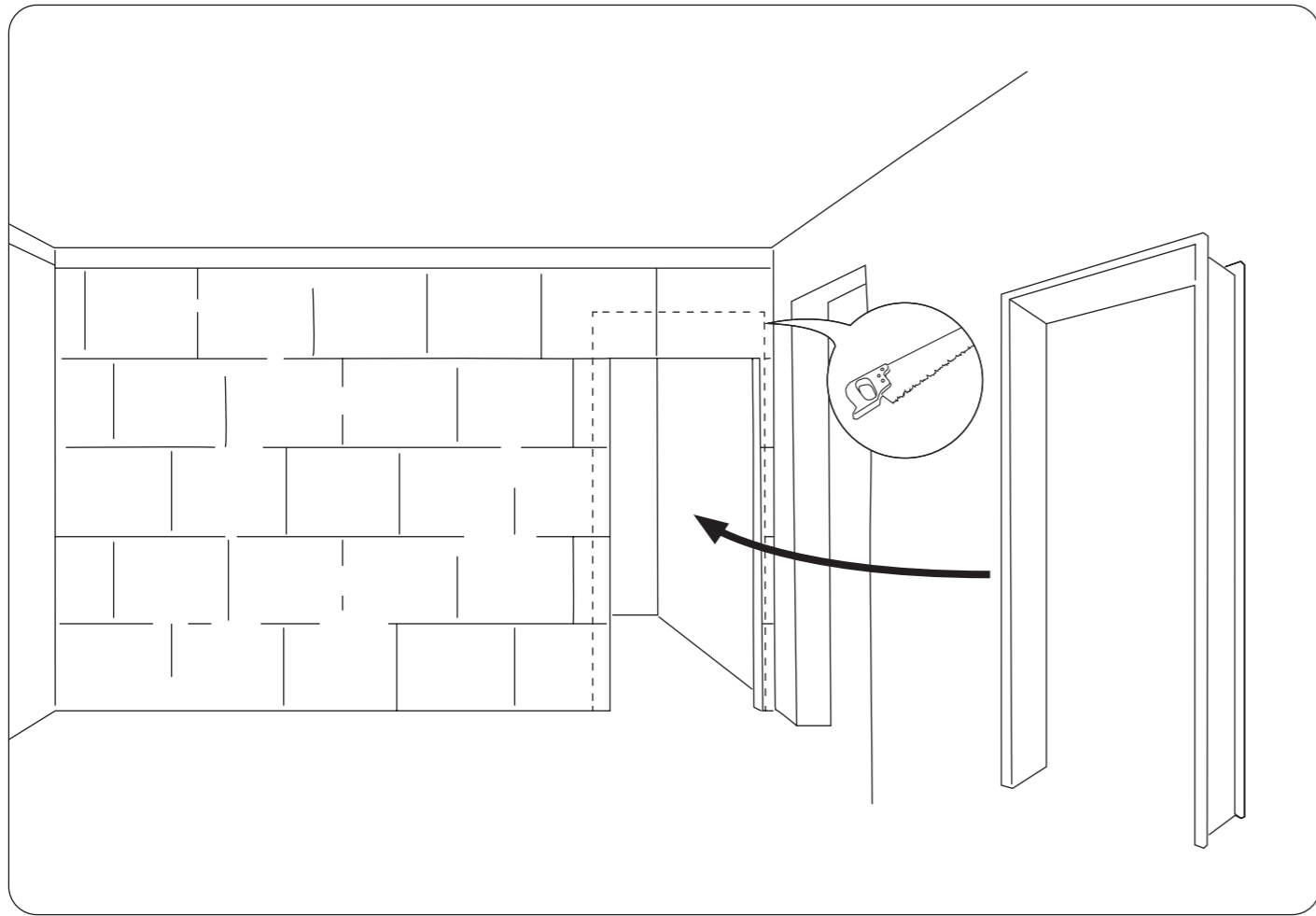

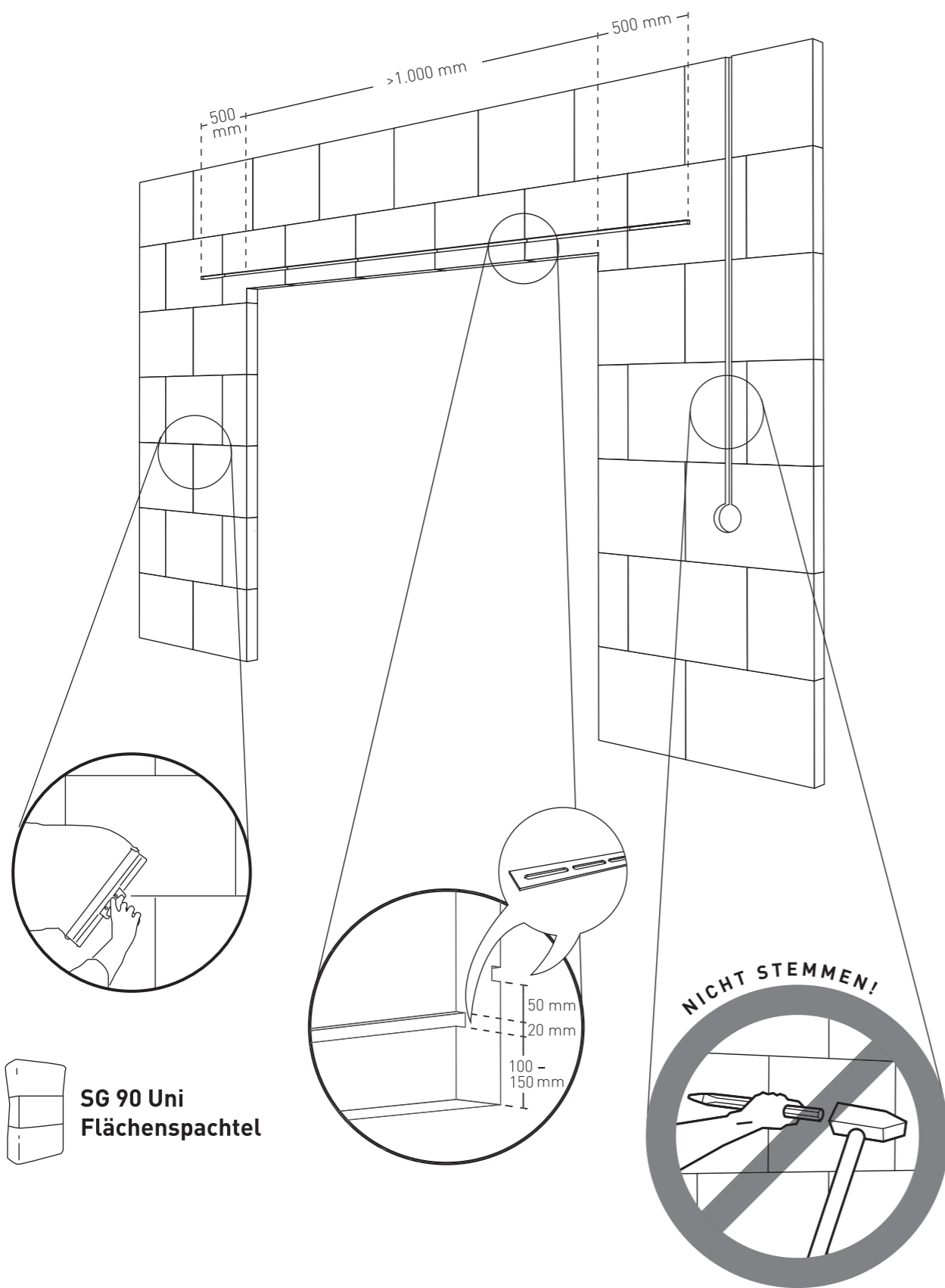

**M100**

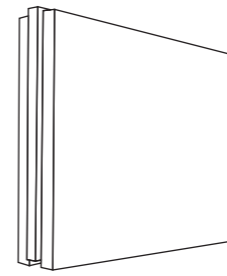

**H3 - Gipsweiß**

**MH100**

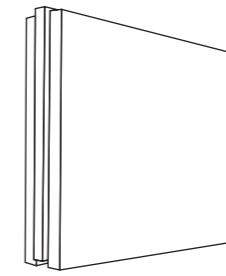

**H2 - Bläulich**

(d)	100 mm		
(l)	666 mm		
(h)	500 mm	(A)	A1
(ρ)	0,85 kg/dm <sup>3</sup>	(F)	180 min
(m)	87 kg/m <sup>2</sup>	(R <sub>w</sub> )	40 dB

**(m<sup>2</sup>) 3x**

**M80**

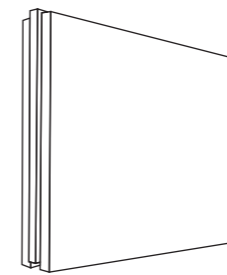

**H3 - Gipsweiß**

**MH80**

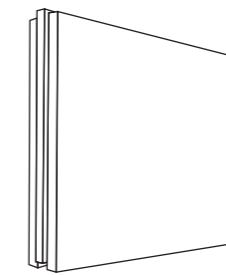

**H2 - Bläulich**

(d)	80 mm		
(l)	666 mm		
(h)	500 mm	(A)	A1
(ρ)	0,85 kg/dm <sup>3</sup>	(F)	120 min
(m)	70 kg/m <sup>2</sup>	(R <sub>w</sub> )	37 dB

**(m<sup>2</sup>) 3x**

**M60**

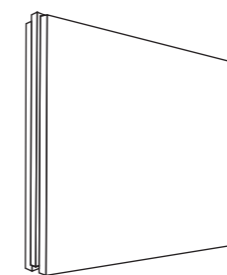

**H3 - Gipsweiß**

**MH60**

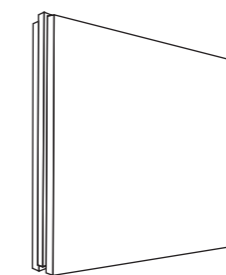

**H2 - Bläulich**

(d)	60 mm		
(l)	666 mm		
(h)	500 mm	(A)	A1
(ρ)	0,93 kg/dm <sup>3</sup>	(F)	30 min
(m)	58 kg/m <sup>2</sup>	(R <sub>w</sub> )	33 dB

**(m<sup>2</sup>) 3x**

**D100-R50**

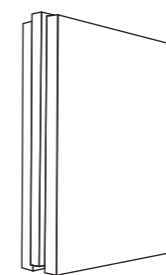

**H3 - Rötlich**

**DH100-R50**

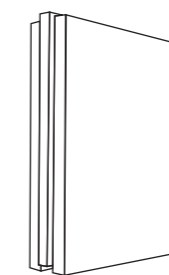

**H2 - Bläulich**

(d)	100 mm		
(l)	400 mm		
(h)	500 mm	(A)	A1
(ρ)	1,4 kg/dm <sup>3</sup>	(F)	180 min
(m)	142 kg/m <sup>2</sup>	(R <sub>w</sub> )	50 dB

**(m<sup>2</sup>) 4x**

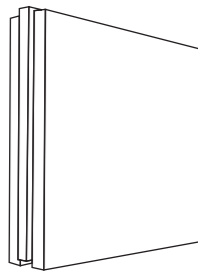
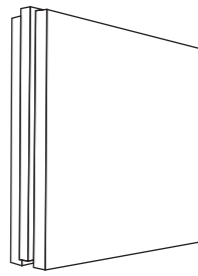
**D100-Rmax****H3 – Rötlich****DH100-Rmax****H2 – Bläulich**

(d) 100 mm  
 (l) 500 mm  
 (h) 500 mm (A) A1  
 (ρ) 1,2 kg/dm<sup>3</sup> (F) 180 min  
 (m) 122 kg/m<sup>2</sup> (R<sub>w</sub>) 46 dB

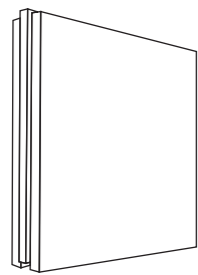
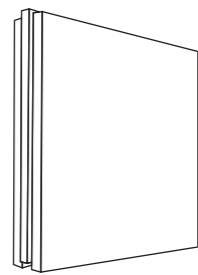
**(m<sup>2</sup>) 4x****D80-Rmax****H3 – Rötlich****DH80-Rmax****H2 – Bläulich**

(d) 80 mm  
 (l) 500 mm  
 (h) 500 mm (A) A1  
 (ρ) 1,4 kg/dm<sup>3</sup> (F) 120 min  
 (m) 114 kg/m<sup>2</sup> (R<sub>w</sub>) 44 dB

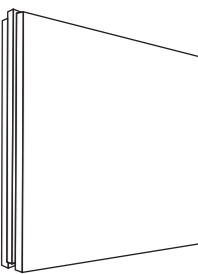
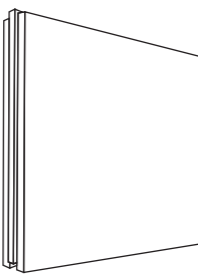
**(m<sup>2</sup>) 4x****D60-Rmax****H3 – Rötlich****DH60-Rmax****H2 – Bläulich**

(d) 60 mm  
 (l) 666 mm  
 (h) 500 mm (A) A1  
 (ρ) 1,2 kg/dm<sup>3</sup> (F) 30 min  
 (m) 74 kg/m<sup>2</sup> (F) 30 min

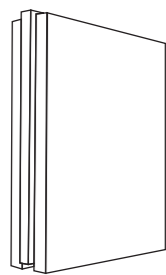
**(m<sup>2</sup>) 3x****D100-R48****H3 – Violett**

(d) 100 mm  
 (l) 400 mm  
 (h) 500 mm (A) A1  
 (ρ) 1,4 kg/dm<sup>3</sup> (F) 180 min  
 (m) 142 kg/m<sup>2</sup> (R<sub>w</sub>) 48 dB

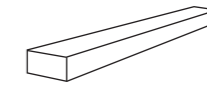
**(m<sup>2</sup>) 5x****AkustikPro  
120-3 / 120-3 sk****AkustikBit  
1000****(m<sup>2</sup>) 1,3 m****Mineralwolle****HydroSocket****(m<sup>2</sup>) 0,4 m**

AkustikPro  
 AkustikBit  
 (B) B2  
 Mineralwolle  
 (A) A1

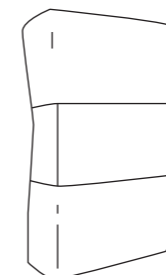
**Gipskleber**

**ClassicWeiss 90**  
**SuperWeiss 120**  
**SuperWeiss 200**  
**Hydro 90**

(t) 90 min (A) A1  
 (t) 120 min  
 (t) 200 min  
 (t) 90 min

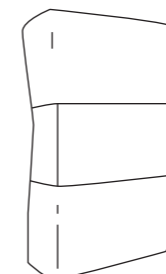
**(m<sup>2</sup>) 1,5 kg****Füllgips**

**FG 70**  
**FG 700**  
**FG 70-B**

(t) 70 min (A) A1  
 (t) 165 min  
 (t) 70 min

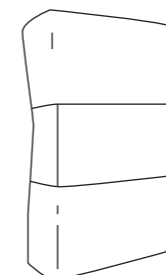
**(m<sup>2</sup>) 2 kg****Spachtelgips**

**SG 90 Uni**  
**Flächenspachtel**

(t) 90 min (A) A1

**(m<sup>2</sup>) 0,8 kg**



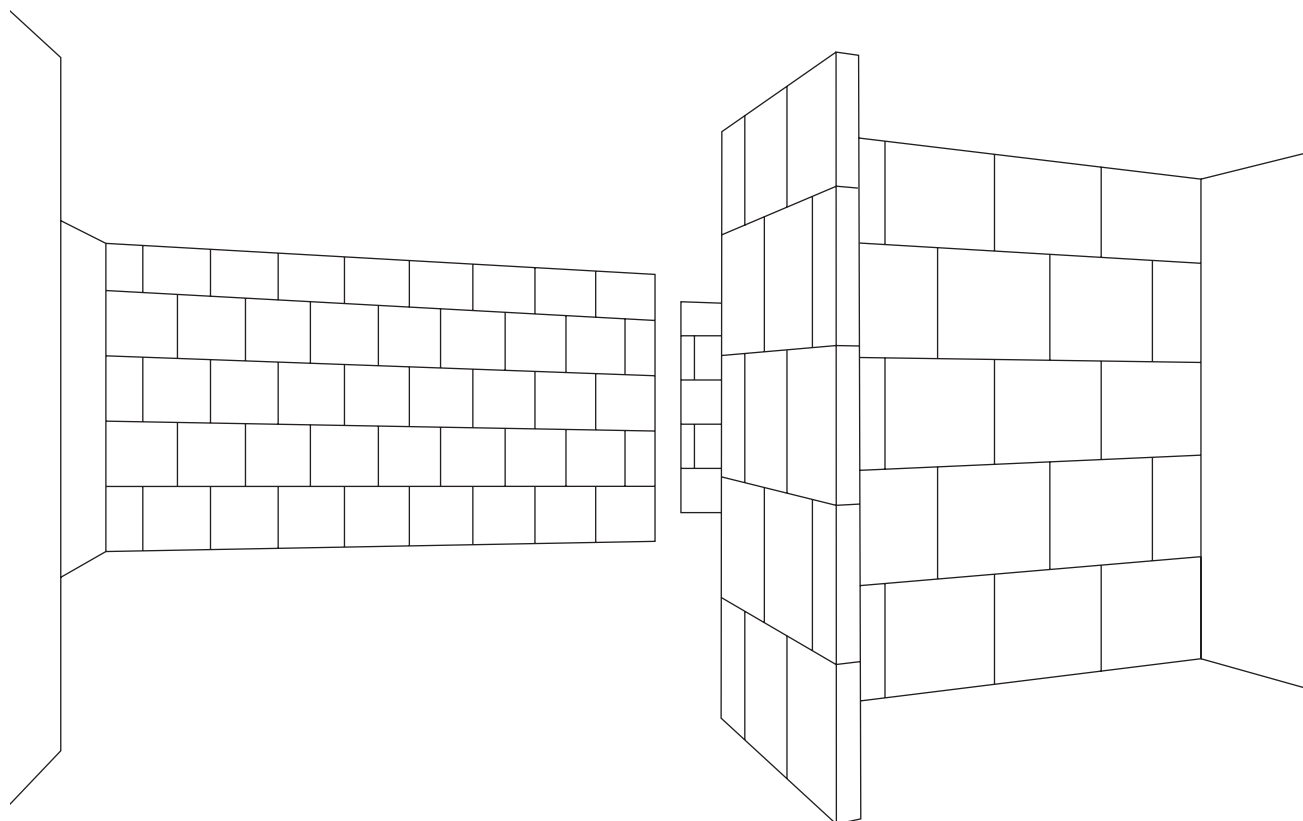

Die technische Unterlage ist gültig ab November 2021.

1. Aufl. 08.2013 (web, print)
2. akt. Aufl. 01.2014 (web, print)
3. akt. Aufl. 06.2015 (web, print)
4. akt. Aufl. 07.2016 (web, print)
5. akt. Aufl. 10.2018 (web, print)
6. akt. Aufl. 10.2020 (web)
7. akt. Aufl. 03.2021 (web, print)
8. akt. Aufl. 11.2021 (web, print)

Abbildungen ausführender Tätigkeiten sind beispielgebend und gelten nur in Verbindung mit der technischen Dokumentation von MultiGips für die Planung und Ausführung von Gips-Wandbauplatten.



**VG-ORTH GmbH & Co. KG**

Holeburgweg 24  
 37627 Stadtoldendorf  
 Telefon +49 5532 505-0  
 Telefax +49 5532 505-560  
 info@multigips.de  
 www.multigips.de