

# MultiGips

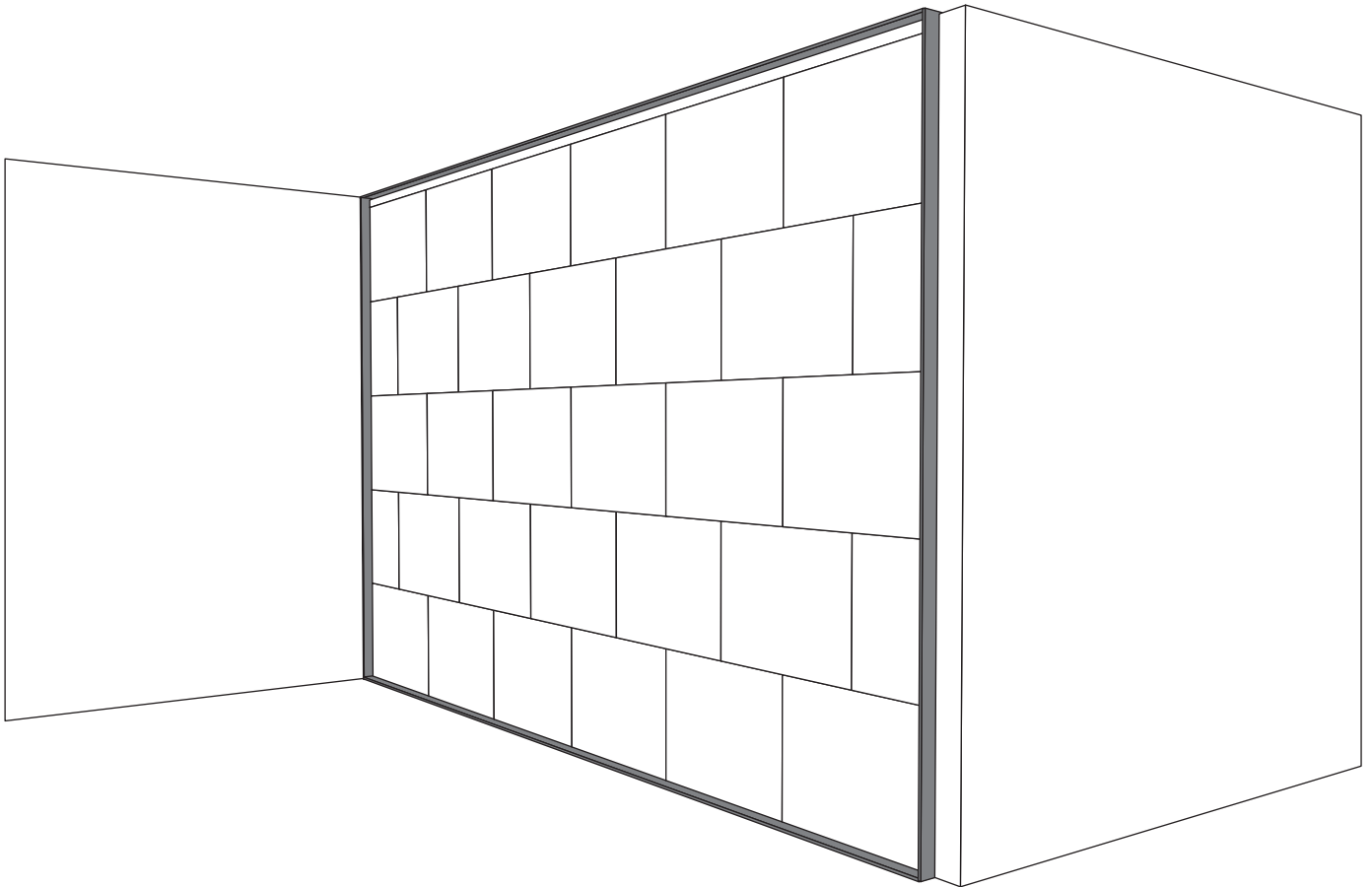

Gips-Wandbauplatten  
Gypsum blocks  
Gipsblokken  
Ptyty gipsowe

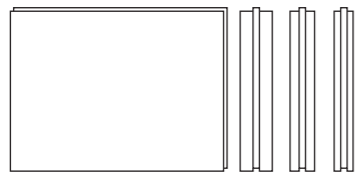



M100  
M80  
M60

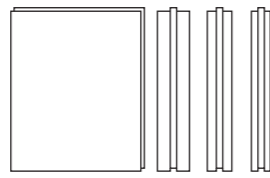

D100-R50  
D100-Rmax  
D80-Rmax  
D60-Rmax



D100-R48

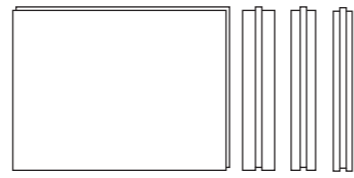

MH100 DH100-Rmax  
MH80 DH80-Rmax  
MH60 DH60-Rmax

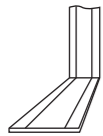
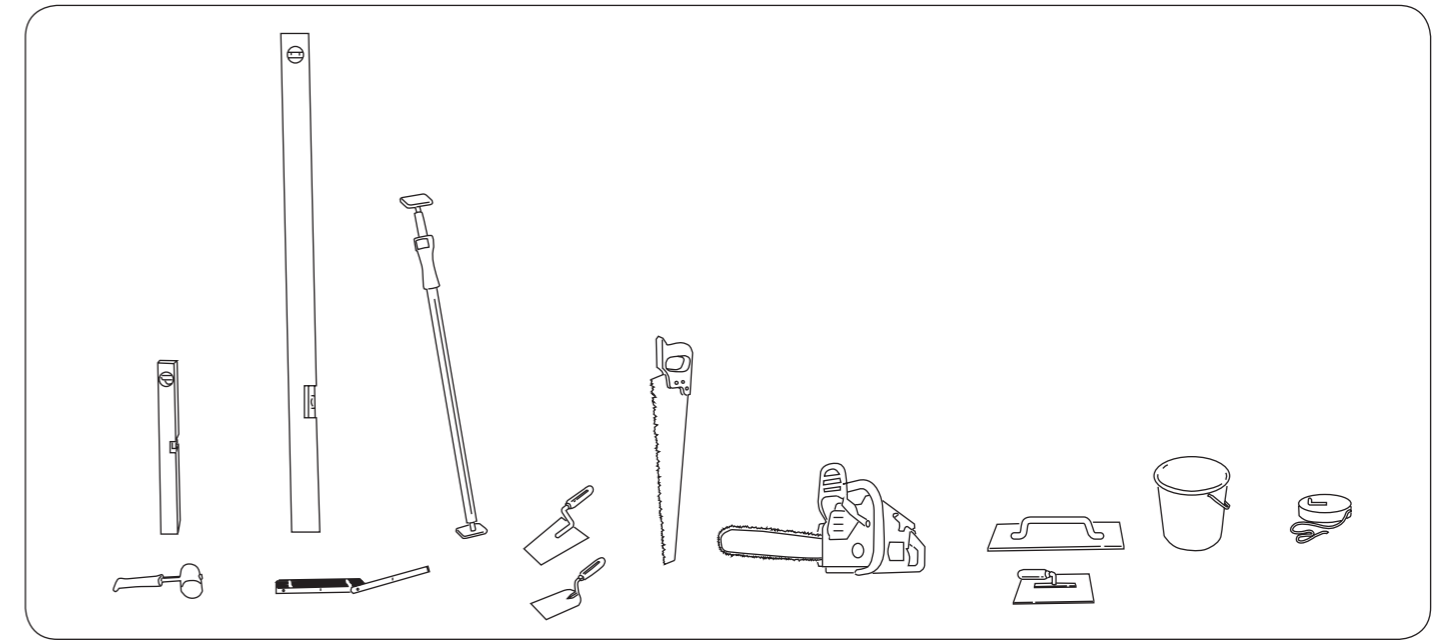

AkustikPro 120-3  
AkustikPro 120-3 sk

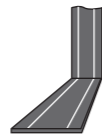

AkustikBit 1000

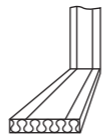

Mineralwolle



1 m<sup>2</sup>

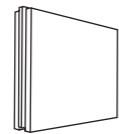

→ 1,3 m

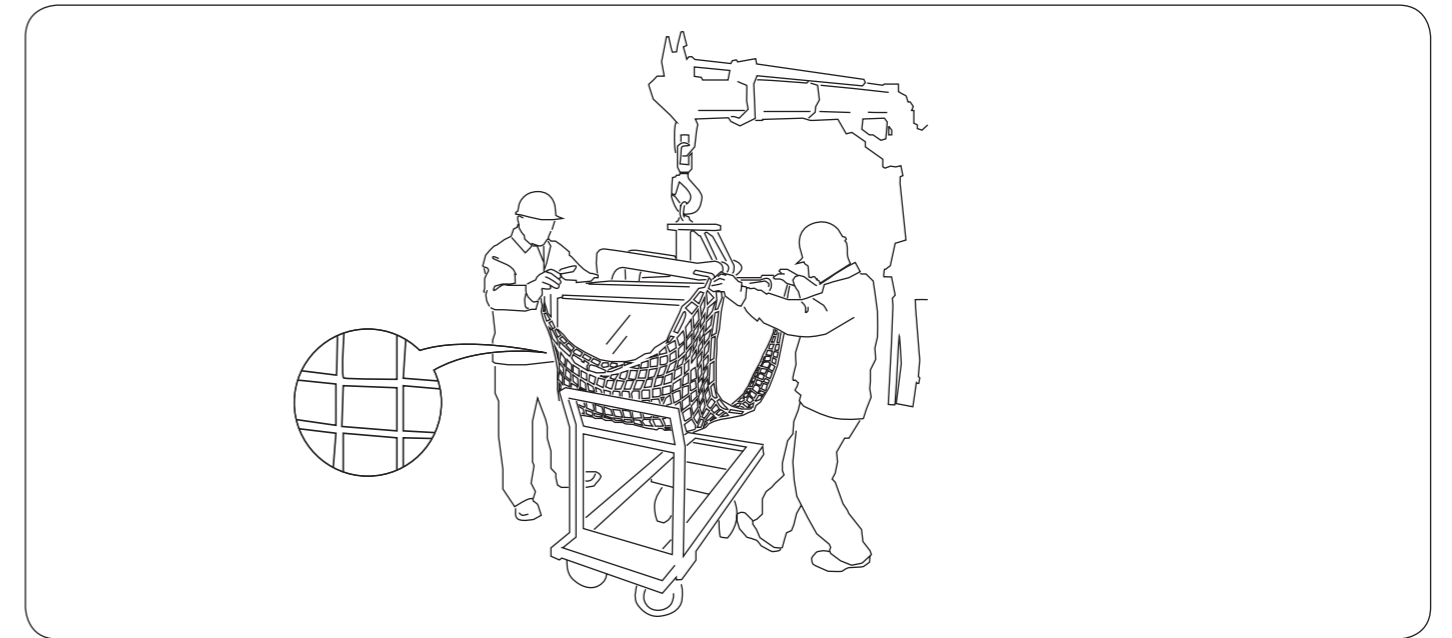

ca. 1,5  
kg/m<sup>2</sup>

Kleber  
ClassicWeiss 90



ca. 1,5  
kg/m<sup>2</sup>

Kleber  
SuperWeiss 120



ca. 2  
kg/m<sup>2</sup>

FG 70 Füll- und  
Zargengips



ca. 2  
kg/m<sup>2</sup>

FG 70-B Füll-  
und Zargengips



ca. 0,8  
kg/m<sup>2</sup>/  
mm

SG 90 Uni  
Flächenspachtel



Kleber  
Hydro 90



Kleber  
SuperWeiss 200



FG 700 Füllgips  
Spezial

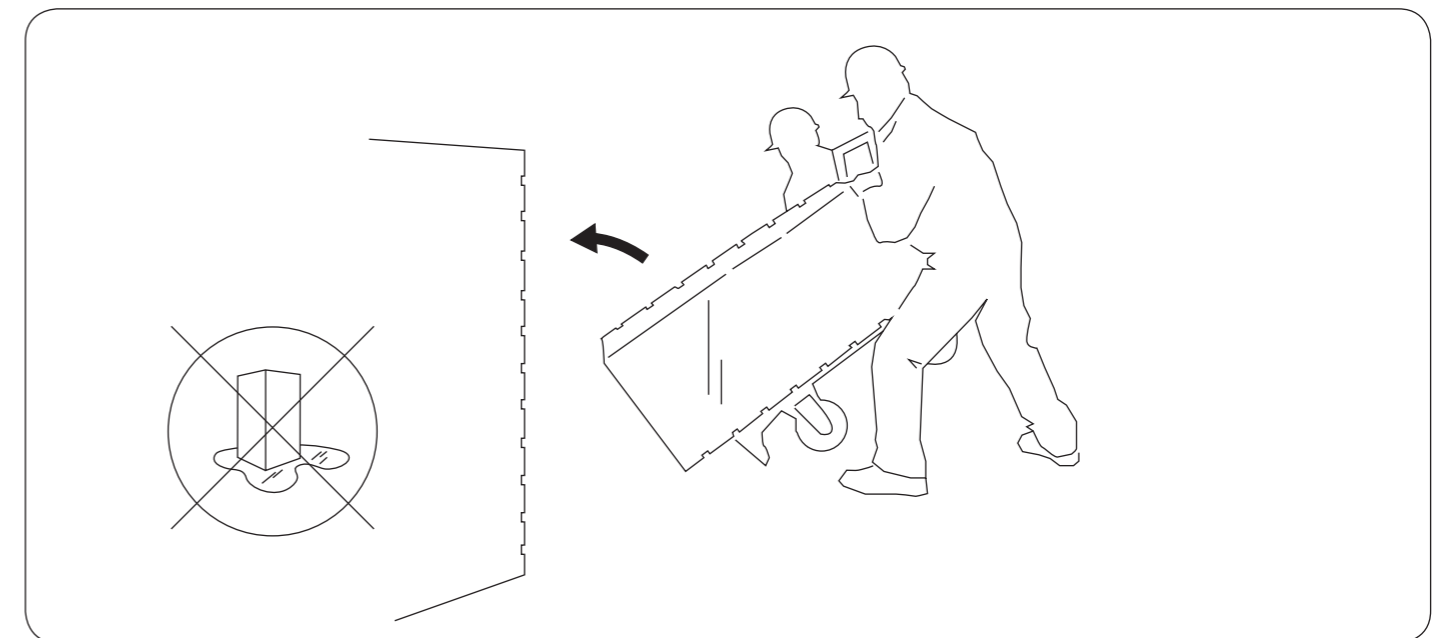

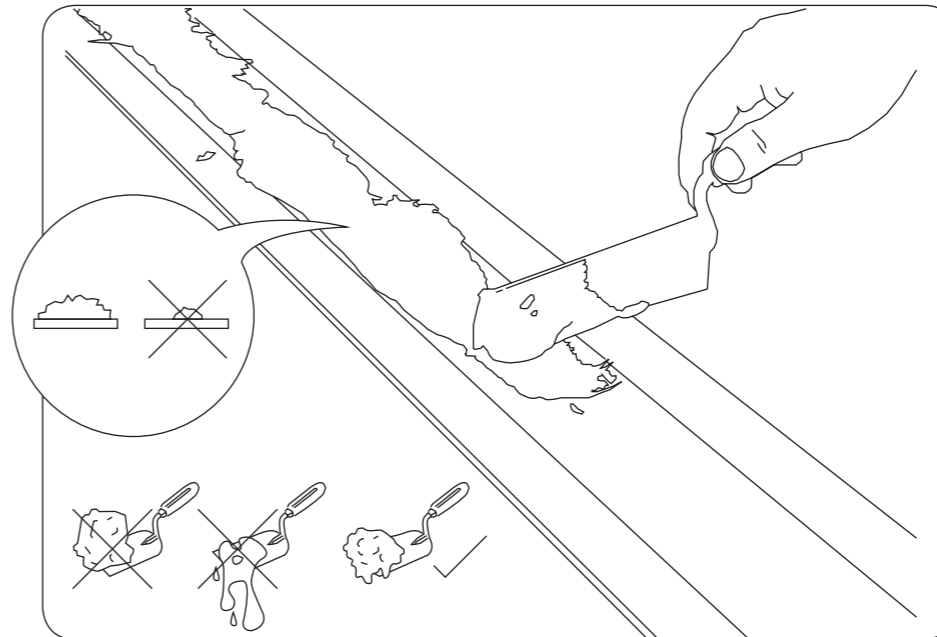
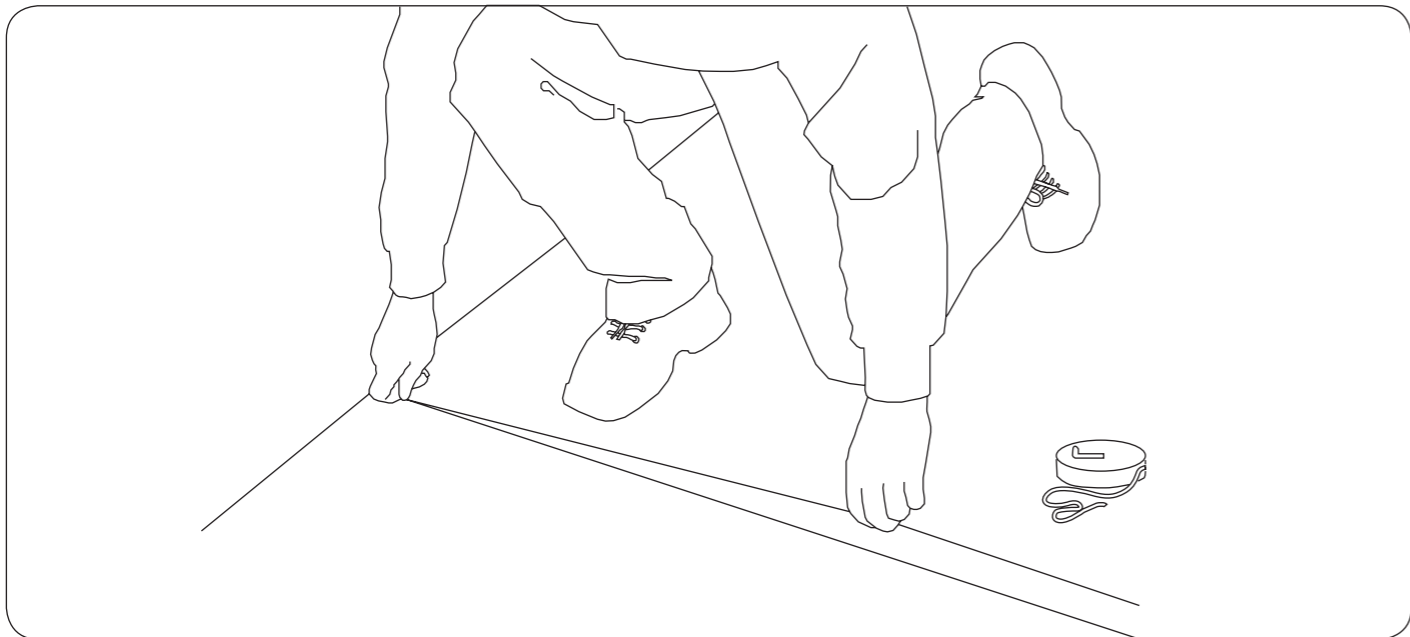

**Kleber  
ClassicWeiss 90**



**Kleber  
SuperWeiss 120/200**



**Kleber  
Hydro 90** 

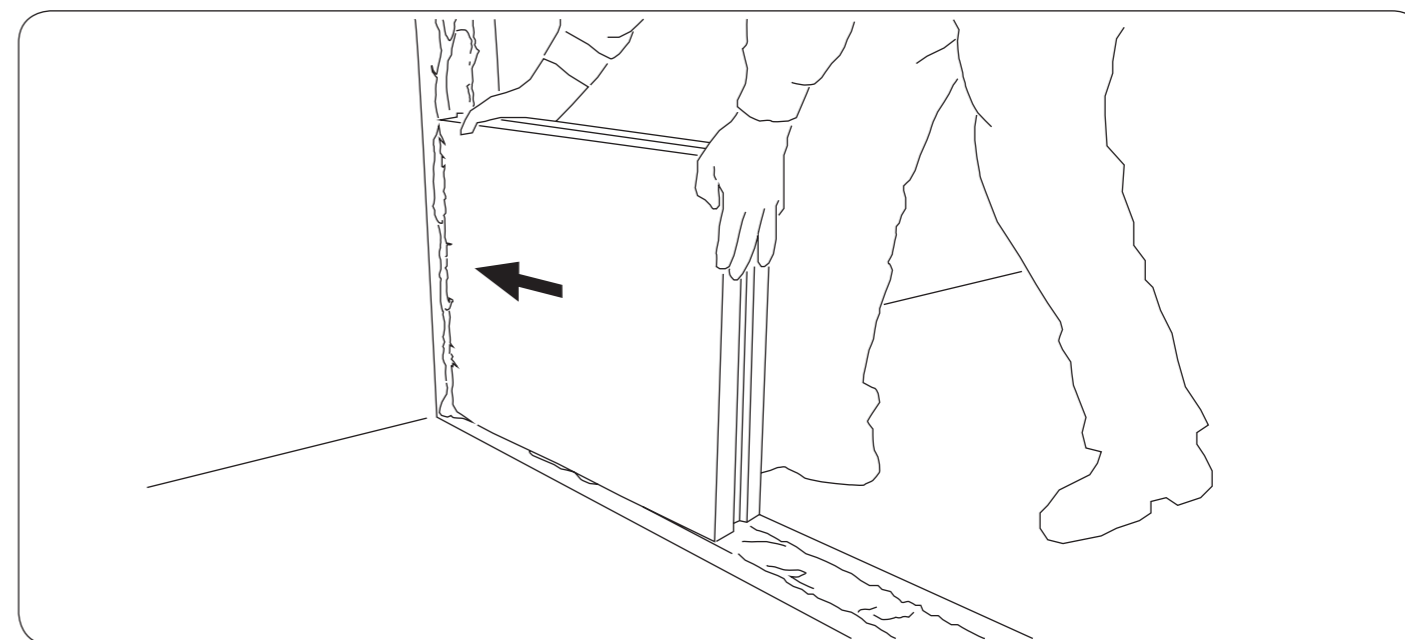
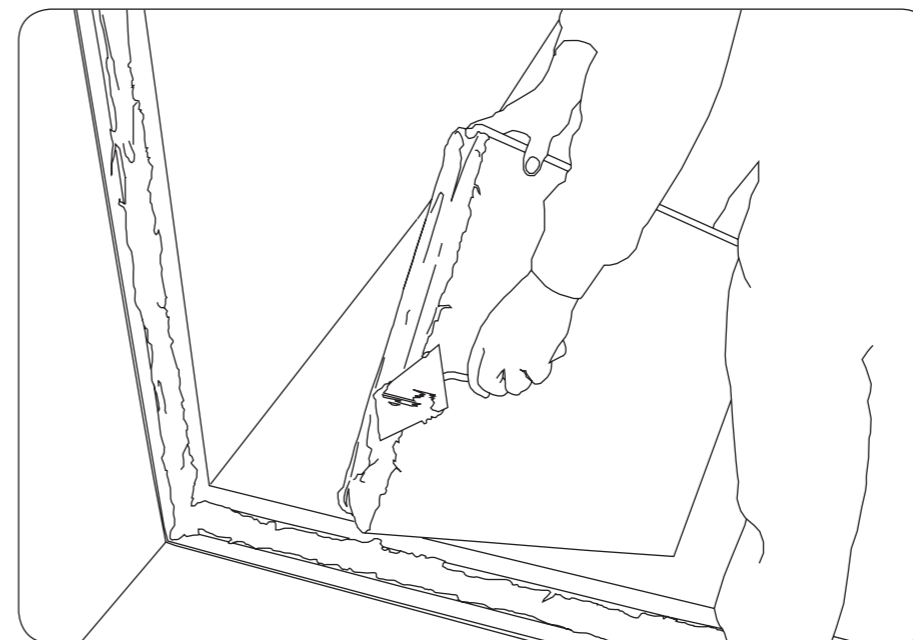
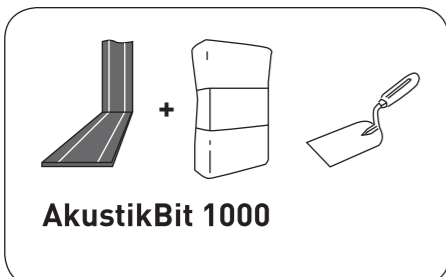
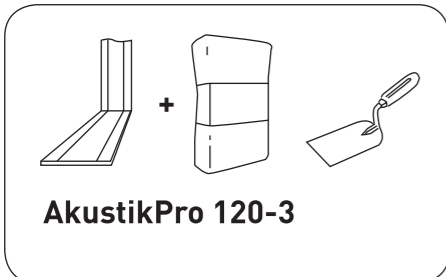
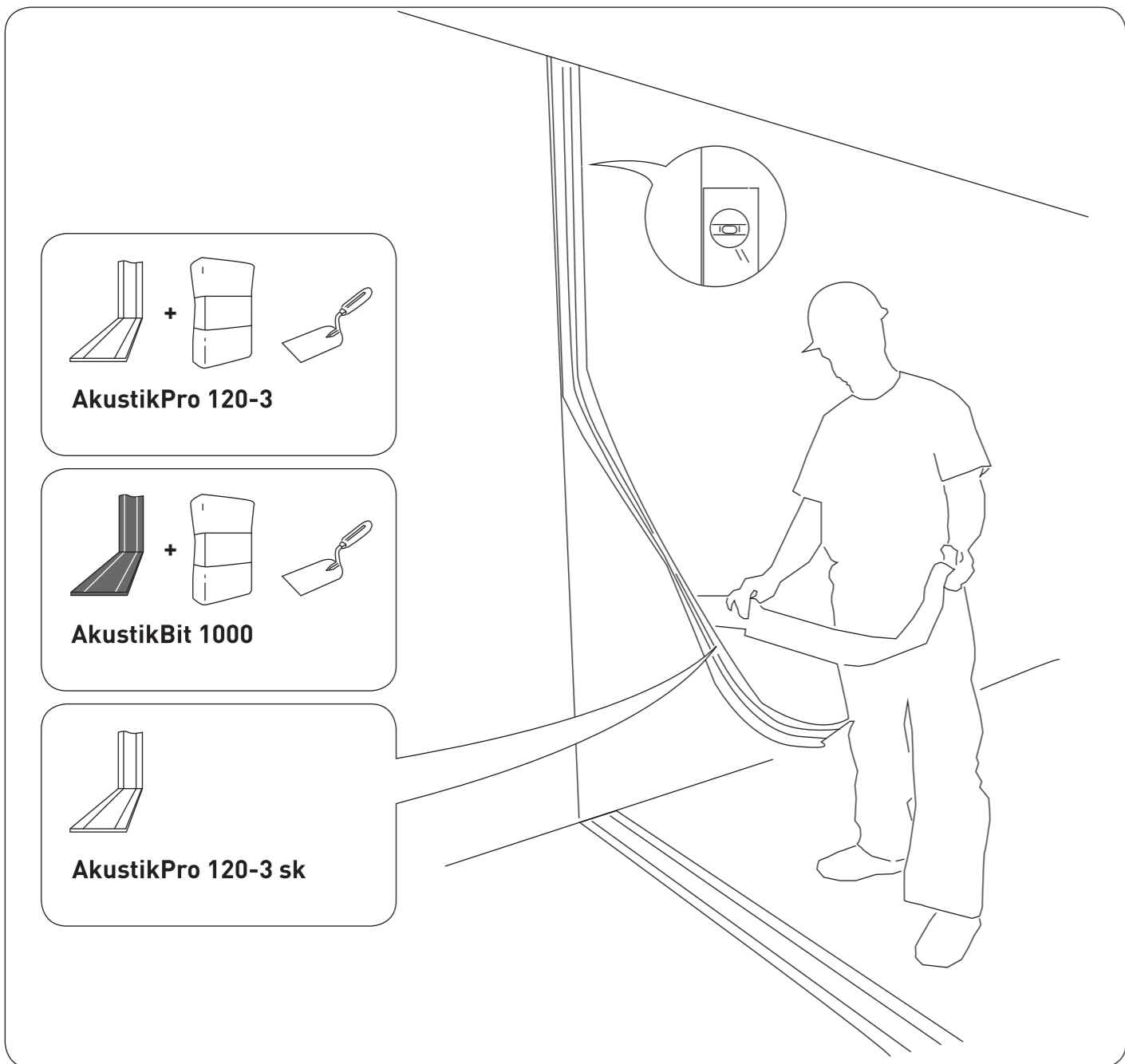
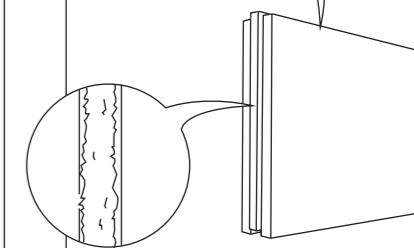
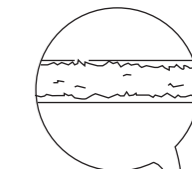

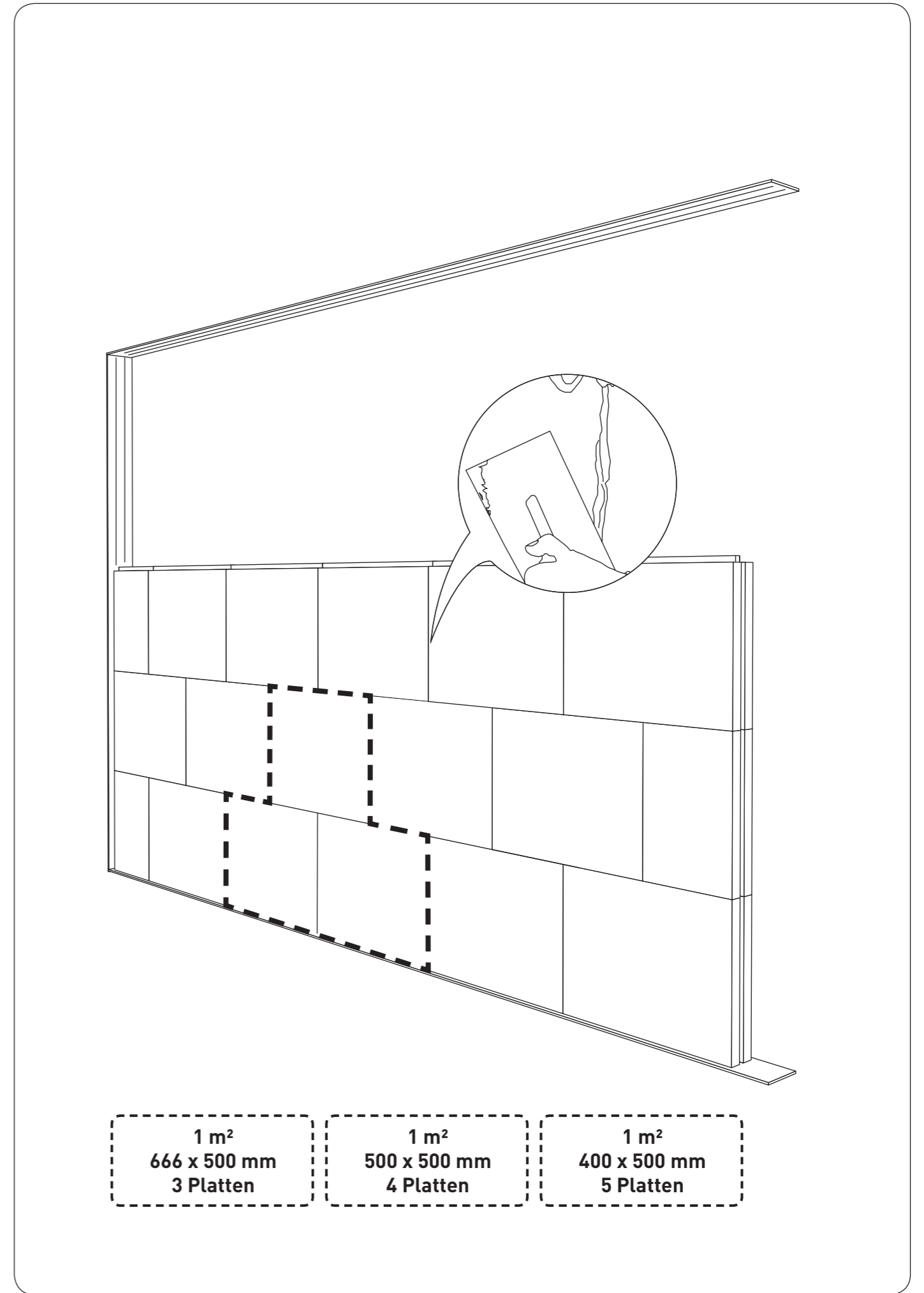
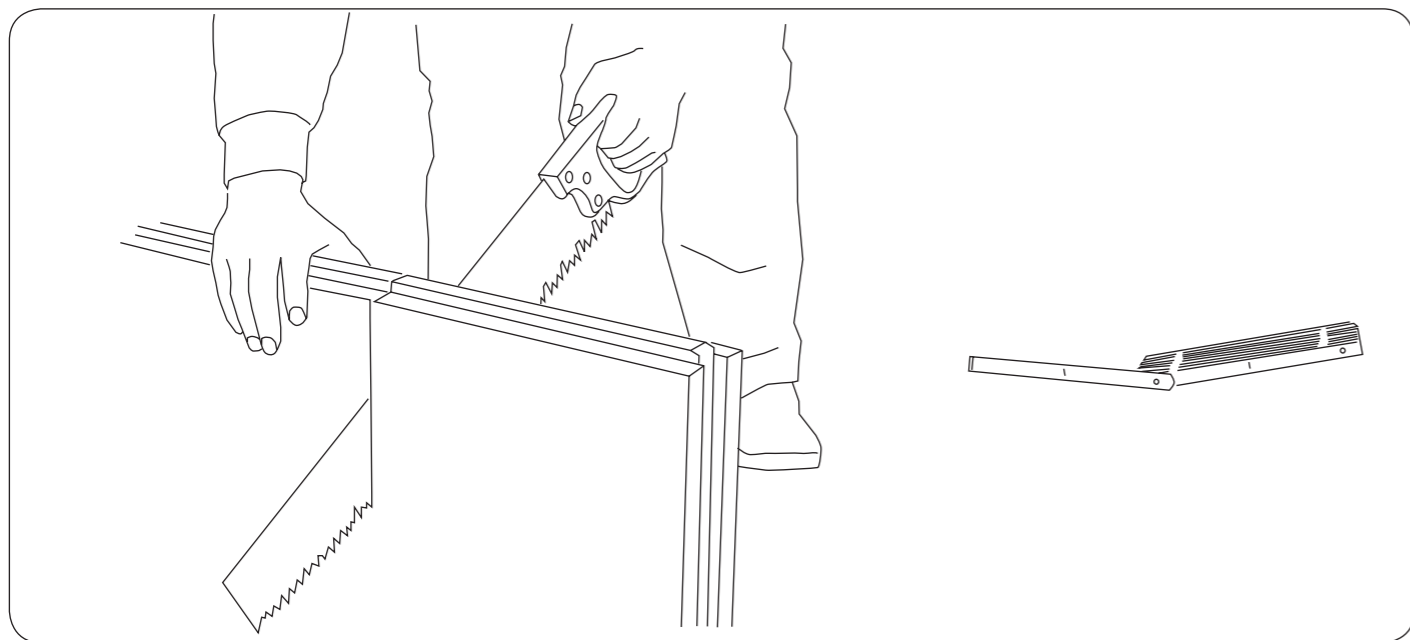
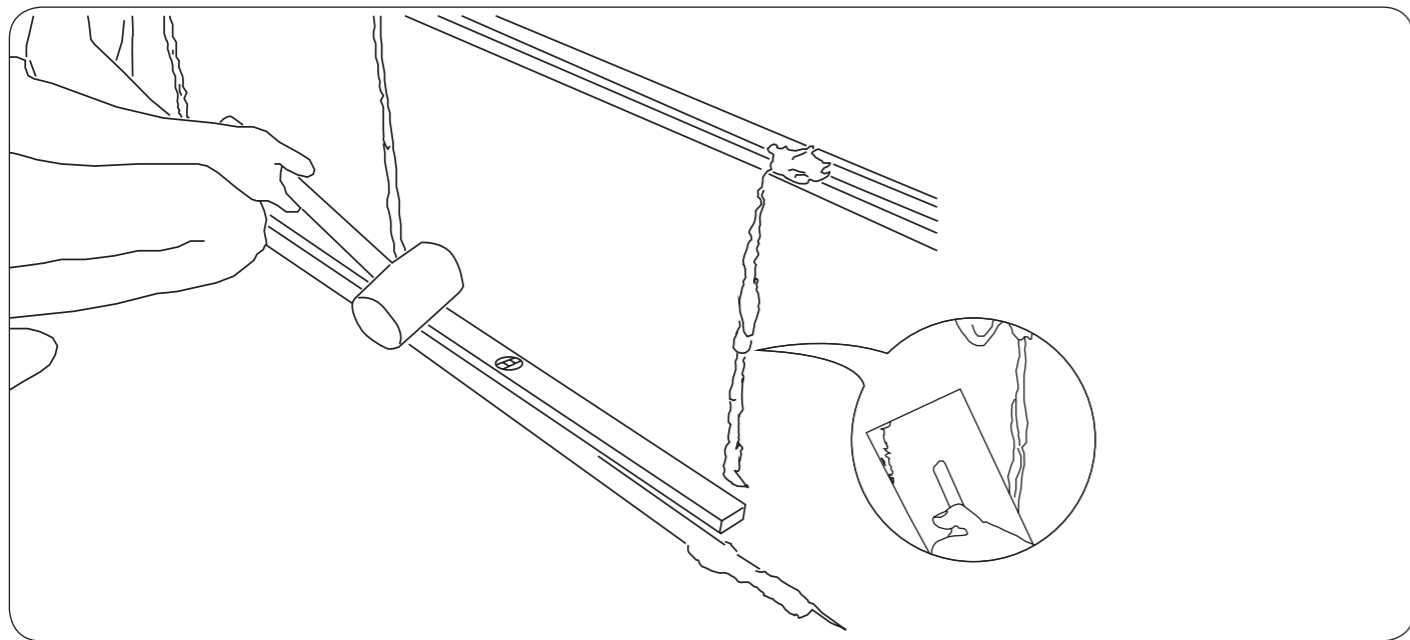
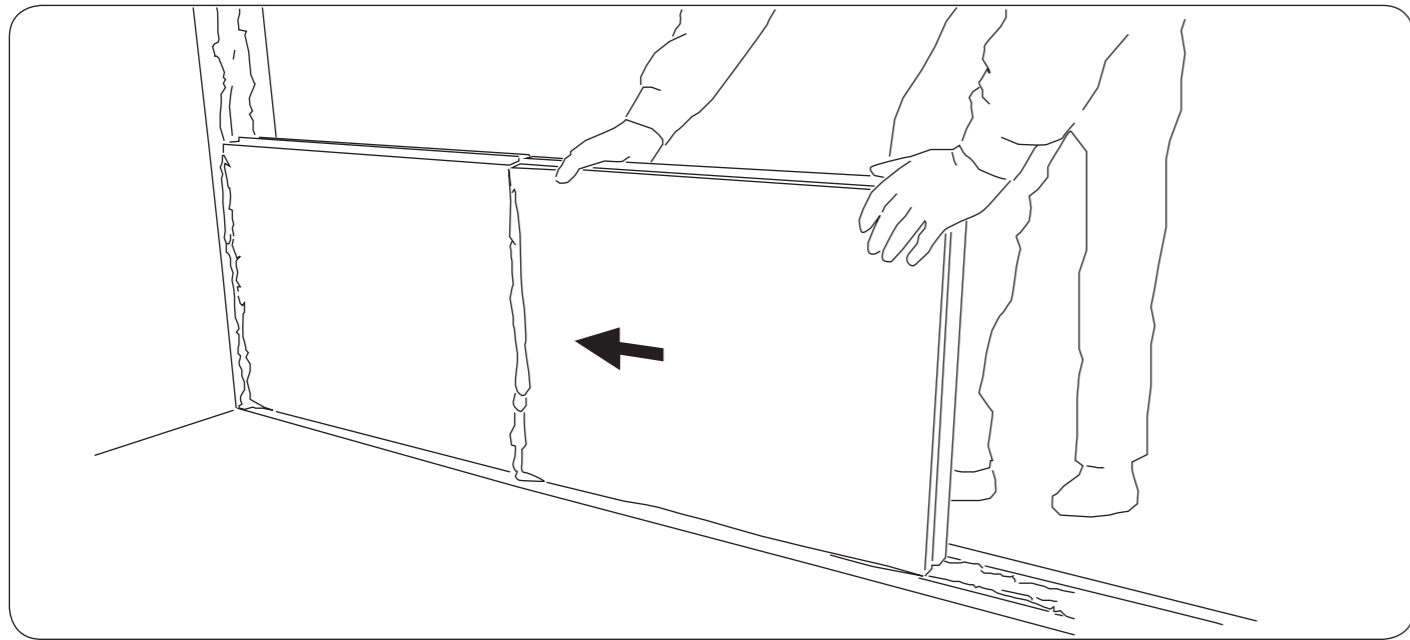

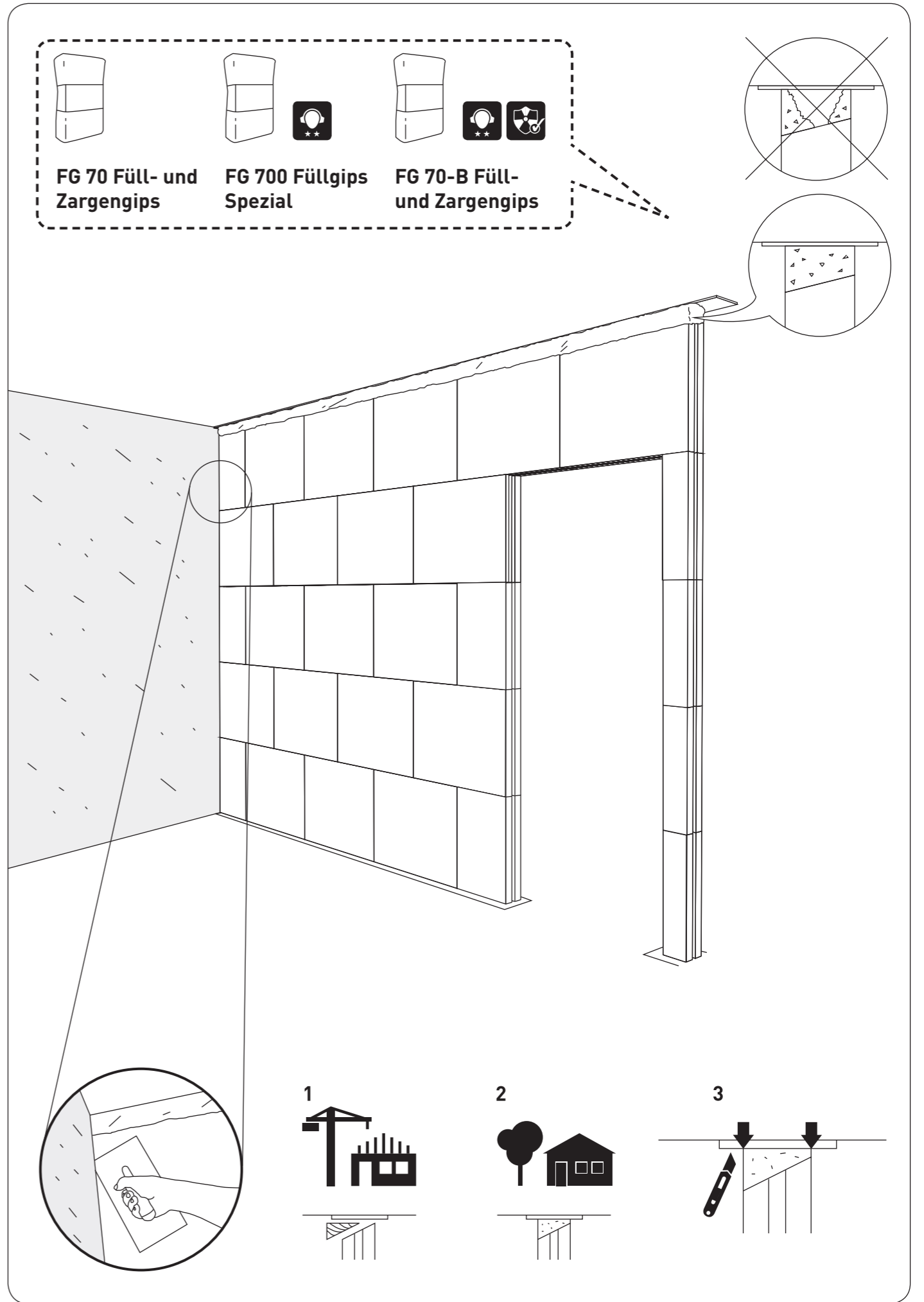
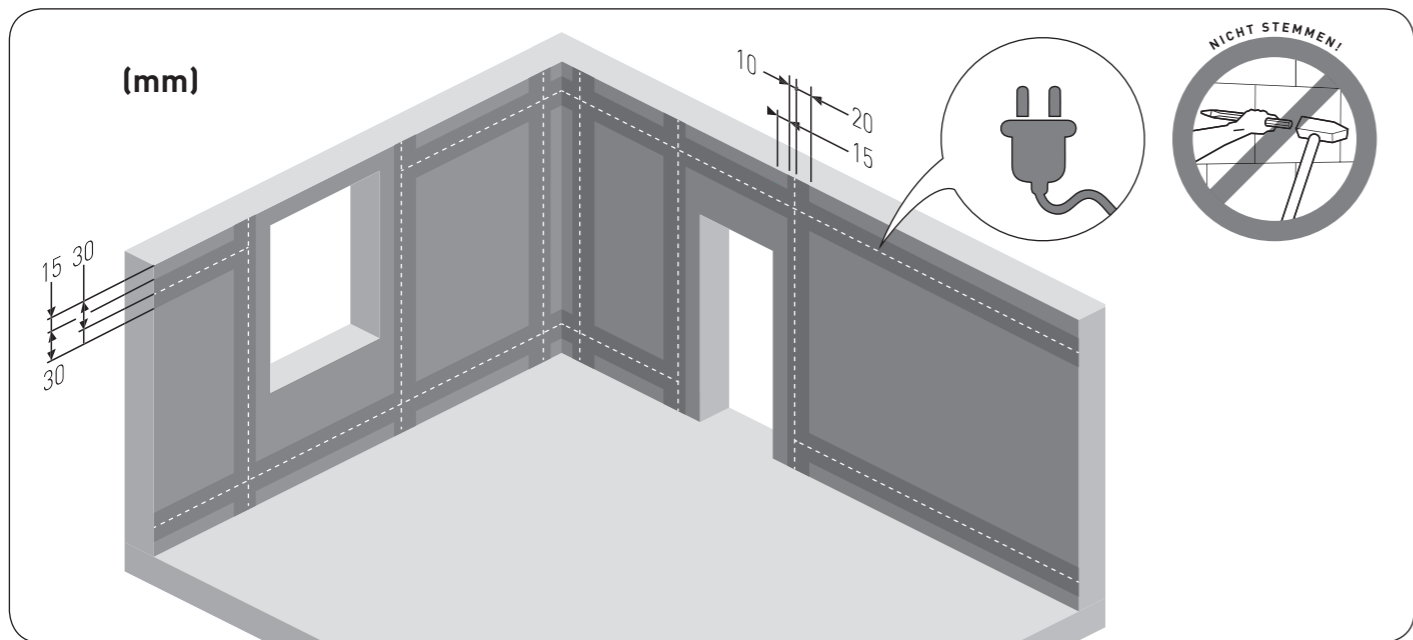
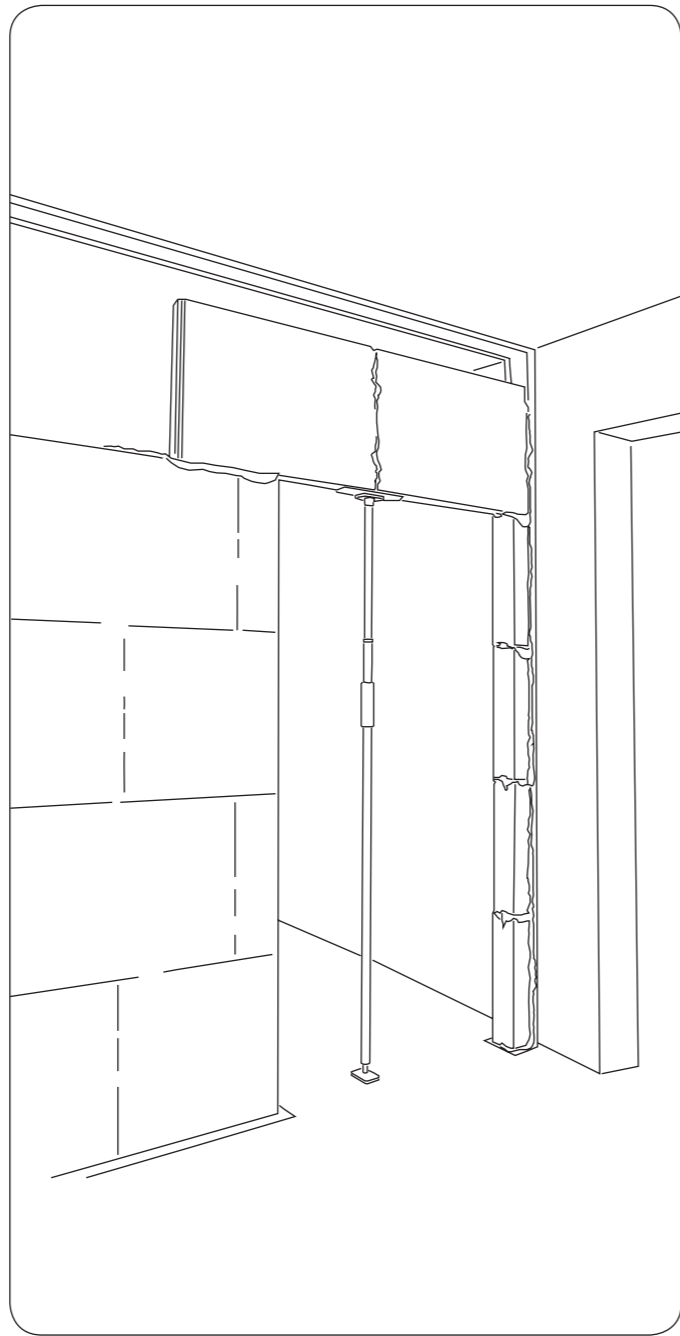
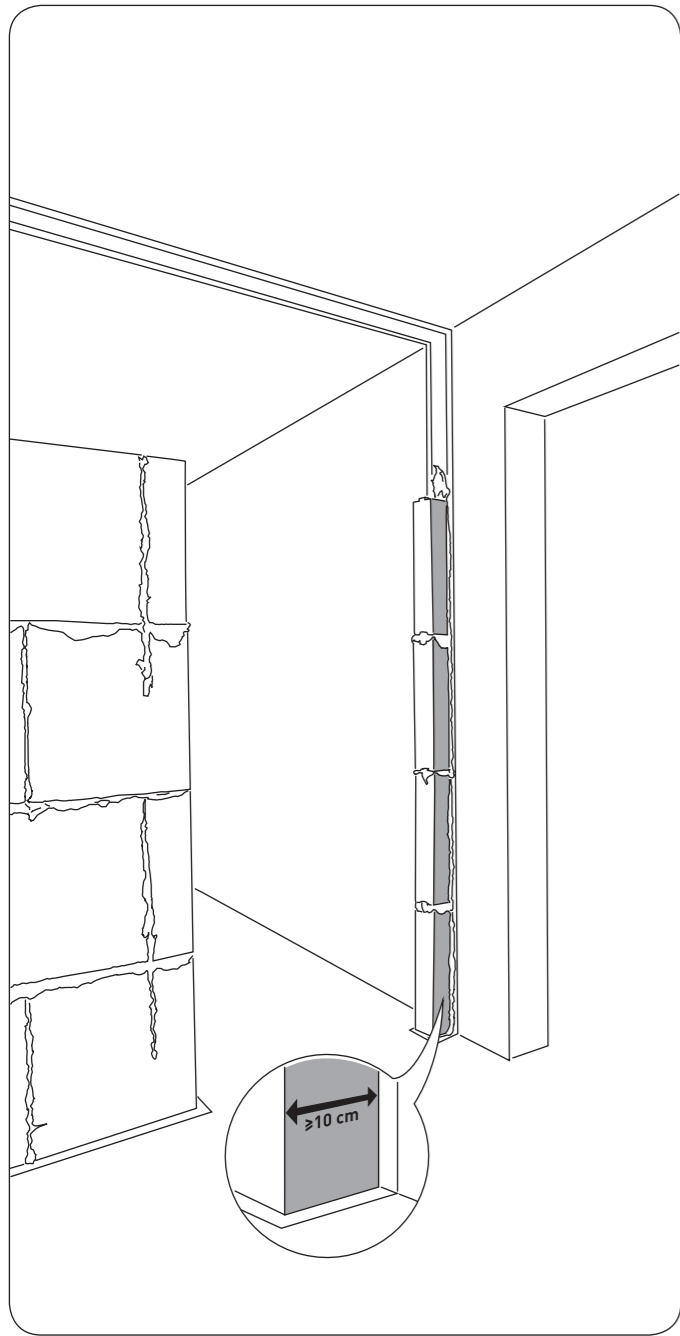

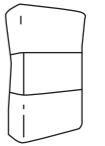
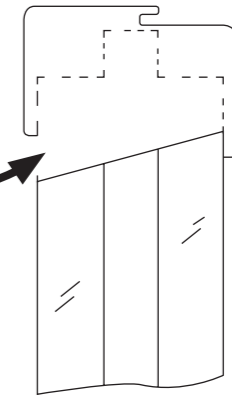
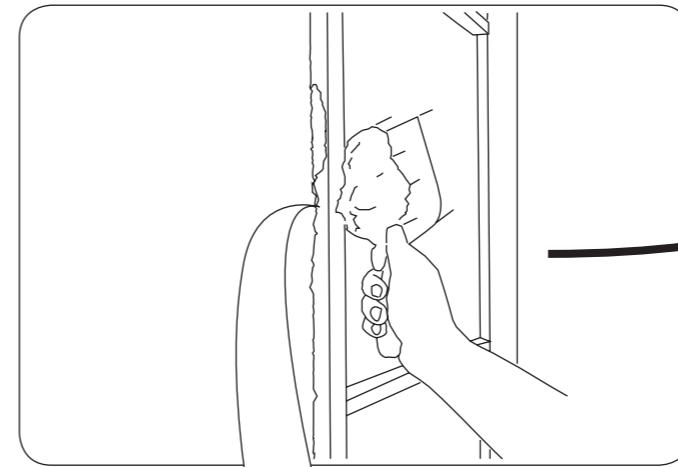
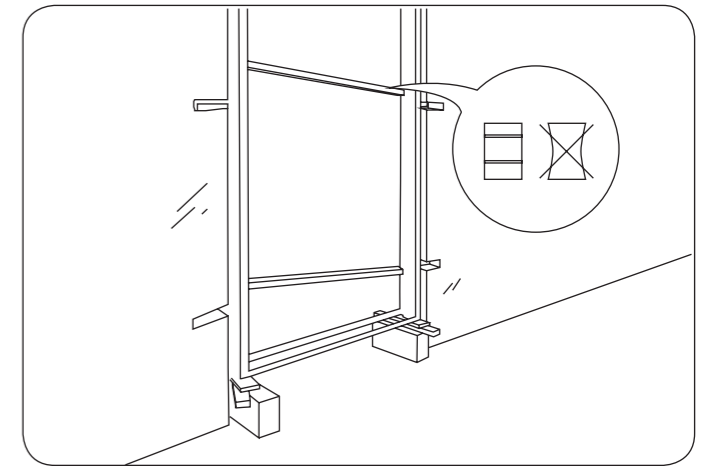
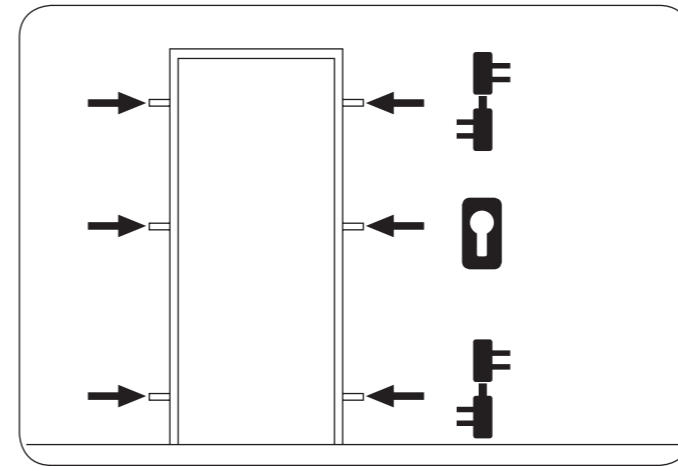
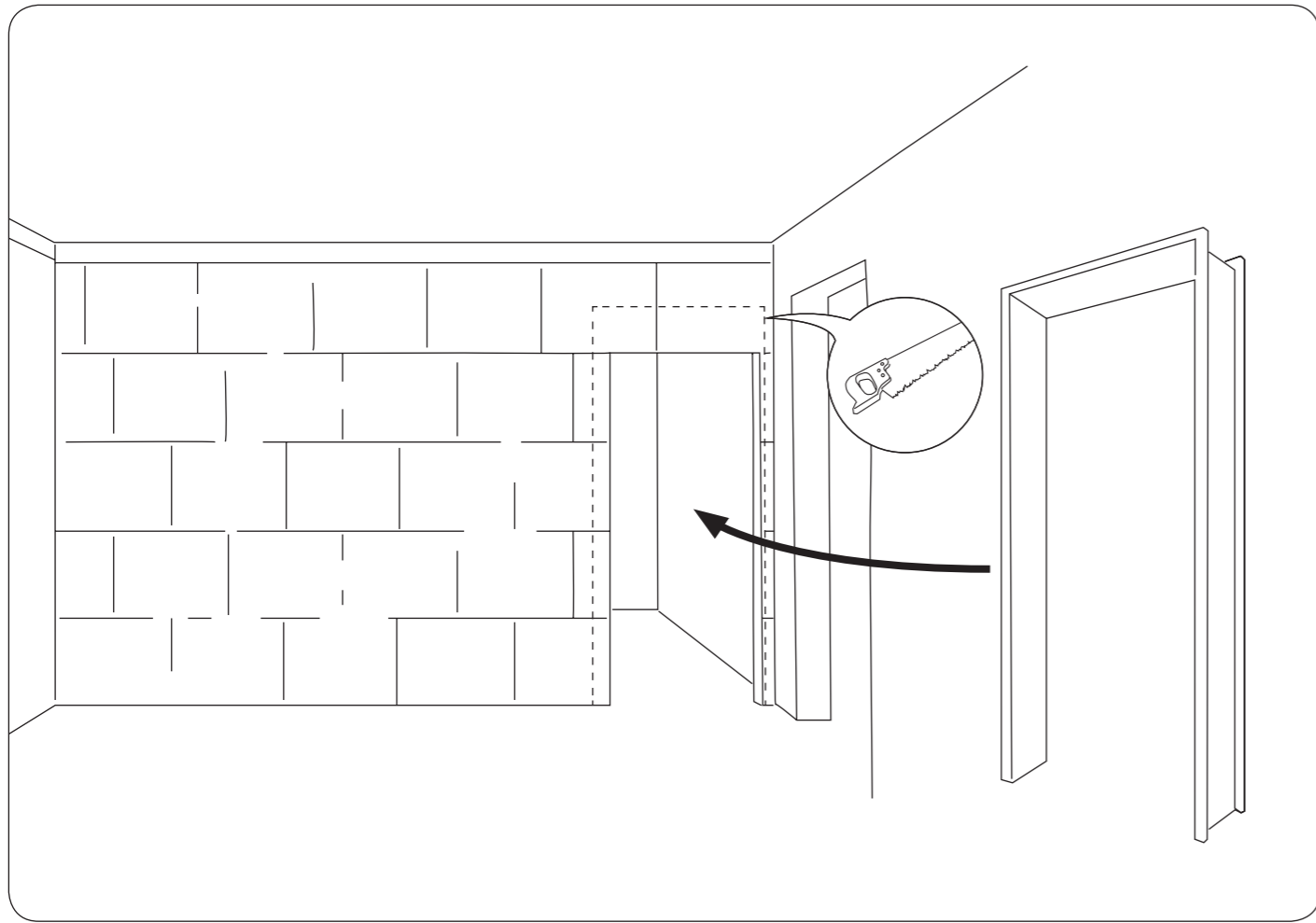

**FG 70/FG 700/  
FG 70-B  
Füll- und  
Zargengips**

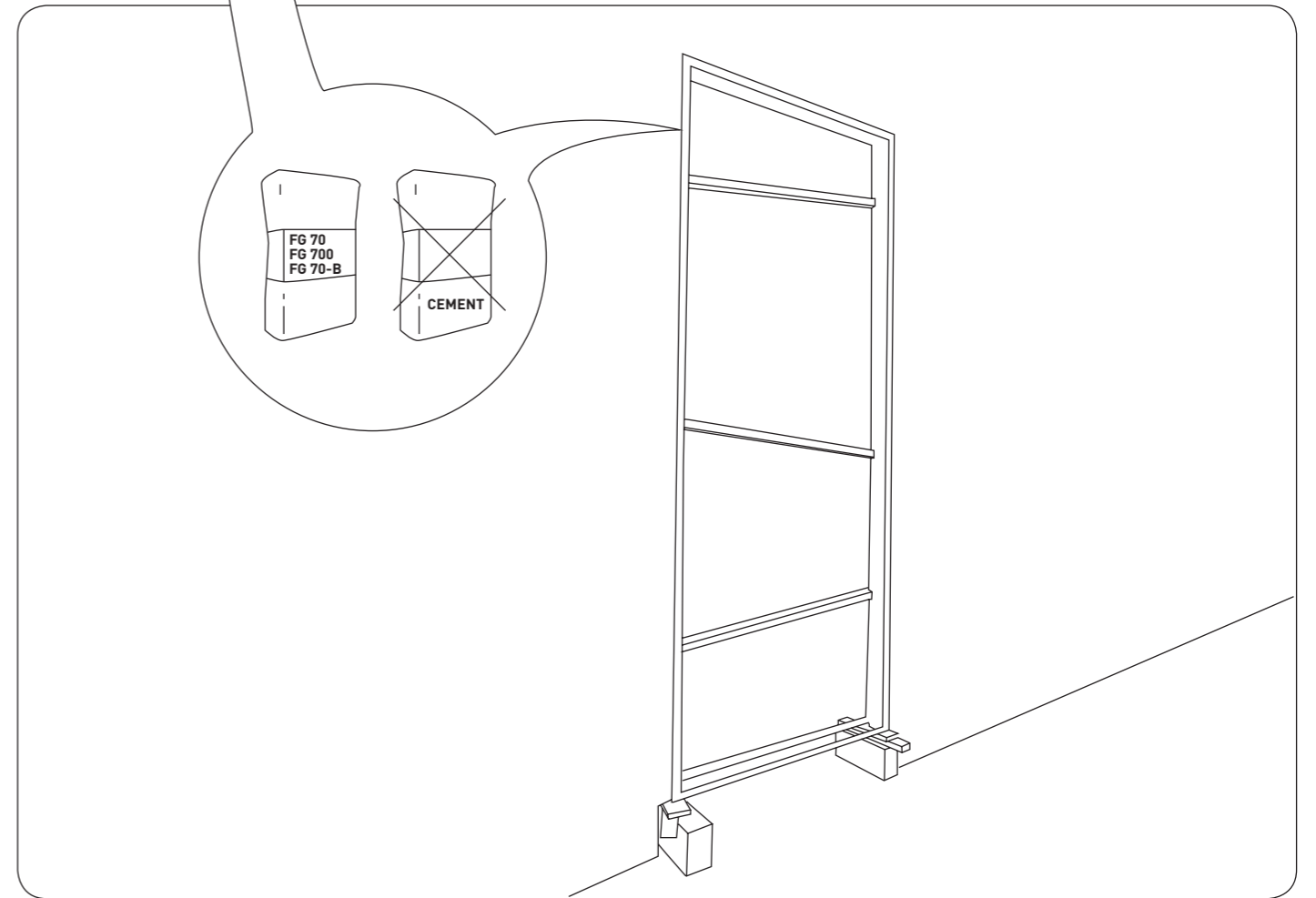
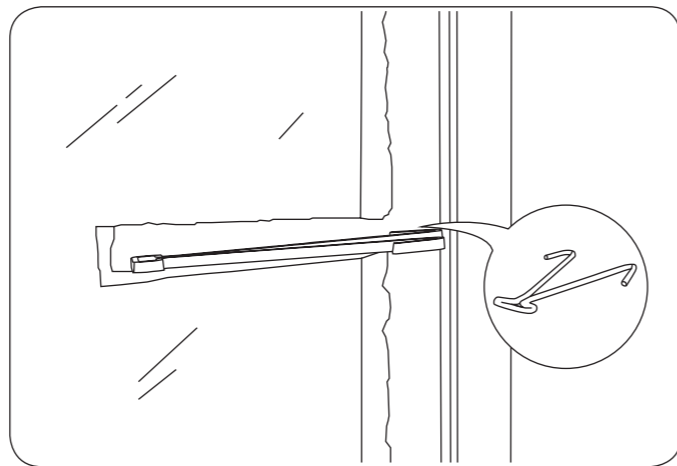
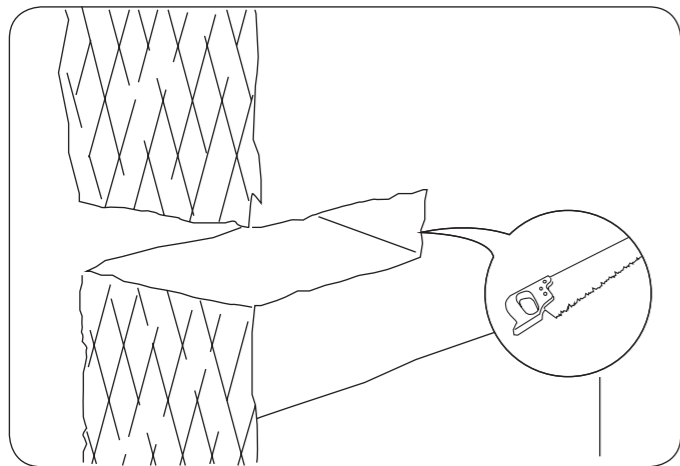
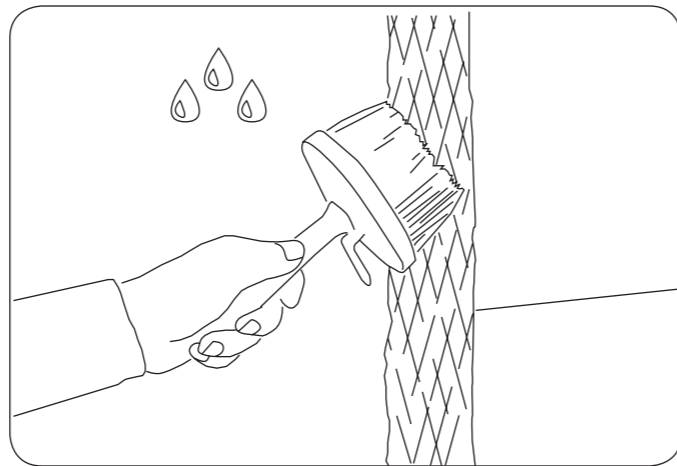
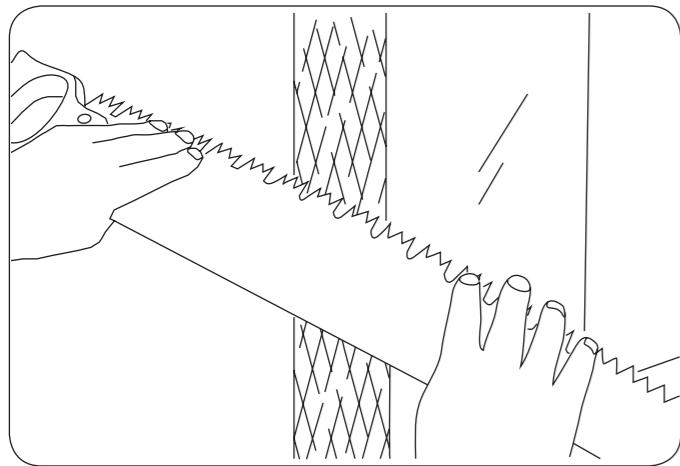

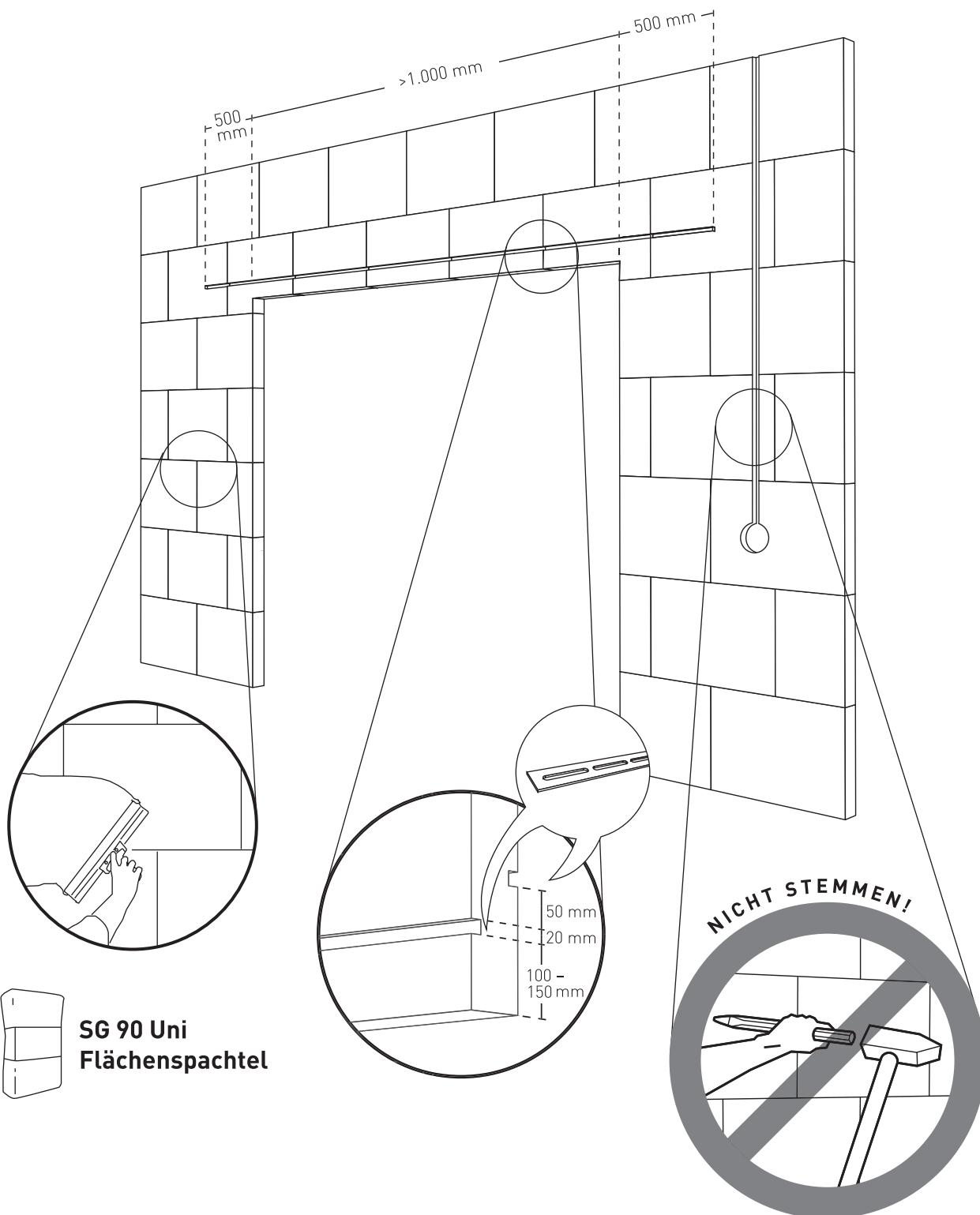

**SG 90 Uni  
Flächenpachtel**



**VG-ORTH GmbH & Co. KG**  
 Holeburgweg 24  
 37627 Stadtoldendorf  
 Telefon +49 5532 505-0  
 Telefax +49 5532 505-560  
 info@multigips.de  
 www.multigips.de

Die technische Unterlage ist gültig ab März 2021.

- 1. Aufl. 08.2013 (web, print), 2. akt. Aufl. 01.2014 (web, print), 3. akt. Aufl. 06.2015 (web, print),
- 4. akt. Aufl. 07.2016 (web, print), 5. akt. Aufl. 10.2018 (web, print), 6. akt. Aufl. 10.2020 (web),
- 7. akt. Aufl. 03.2021 (web, print)

Abbildungen ausführender Tätigkeiten sind beispielgebend und gelten nur in Verbindung mit der technischen Dokumentation von MultiGips für die Planung und Ausführung von Gips-Wandbauplatten.