

MultiGips

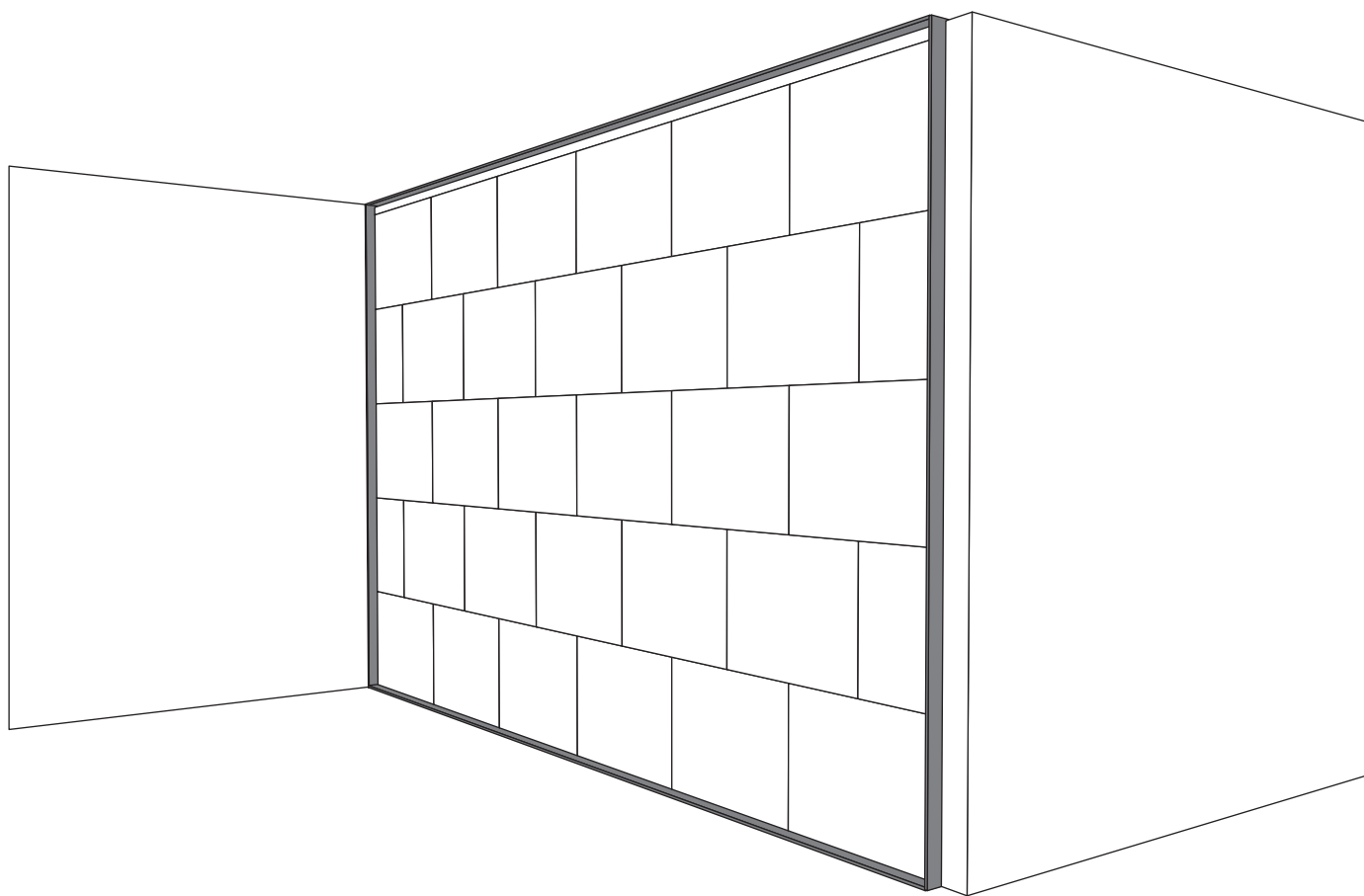

Gips-Wandbauplatten
Gypsum blocks
Gipsblokken
Ptyty gipsowe

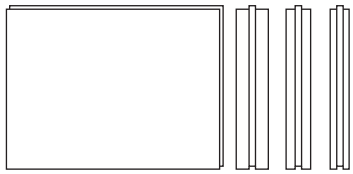



M100
M80
M60

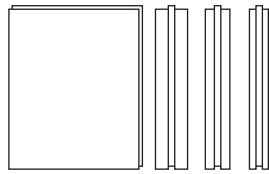

D100-R50
D100-Rmax
D80-Rmax
D60-Rmax



D100-R48

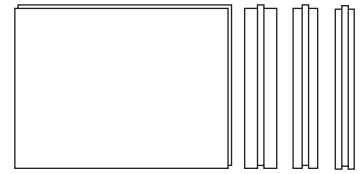

MH100 **DH100-Rmax**
MH80 **DH80-Rmax**
MH60 **DH60-Rmax**

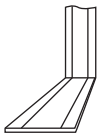

AkustikPro 120-3
AkustikPro 120-3 sk

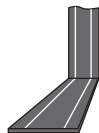

AkustikBit 1000

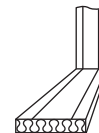

Mineralwolle



1 m²

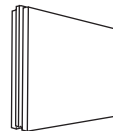

→ 1,3 m

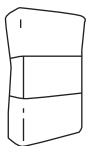

ca. 1,5
kg/m²

**Kleber
ClassicWeiss 90**



ca. 1,5
kg/m²

**Kleber
SuperWeiss 120**



ca. 2
kg/m²

**FG 70 Füll- und
Zargengips**



ca. 2
kg/m²

**FG 70-B Füll-
und Zargengips**



ca. 0,8
kg/m²/
mm

**SG 90 Uni
Flächenspachtel**



**Kleber
Hydro 90**



**Kleber
SuperWeiss 200**



**FG 700 Füllgips
Spezial**



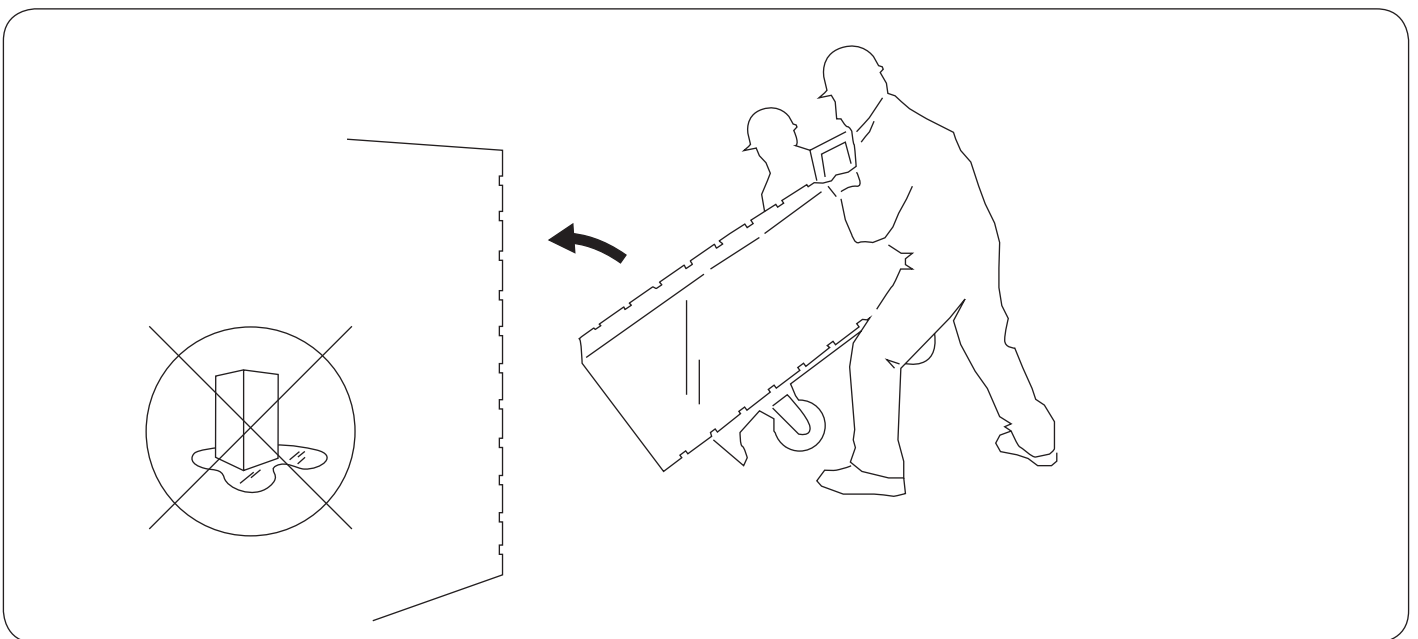
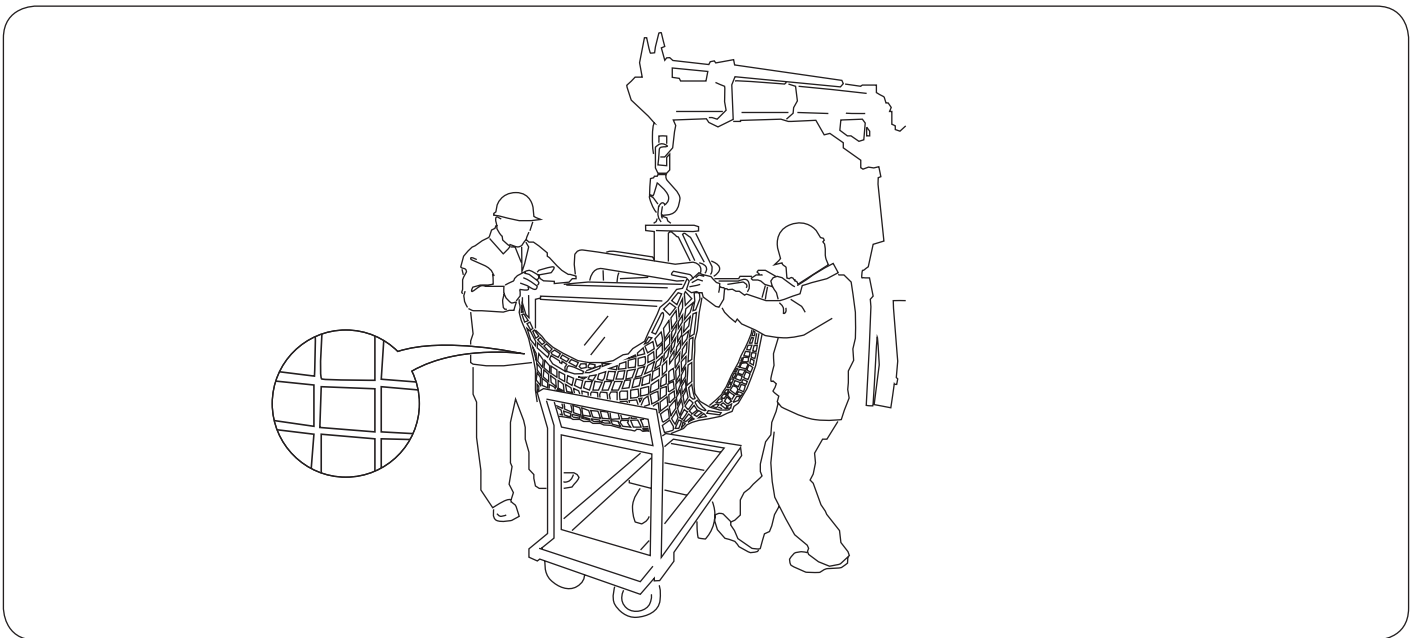
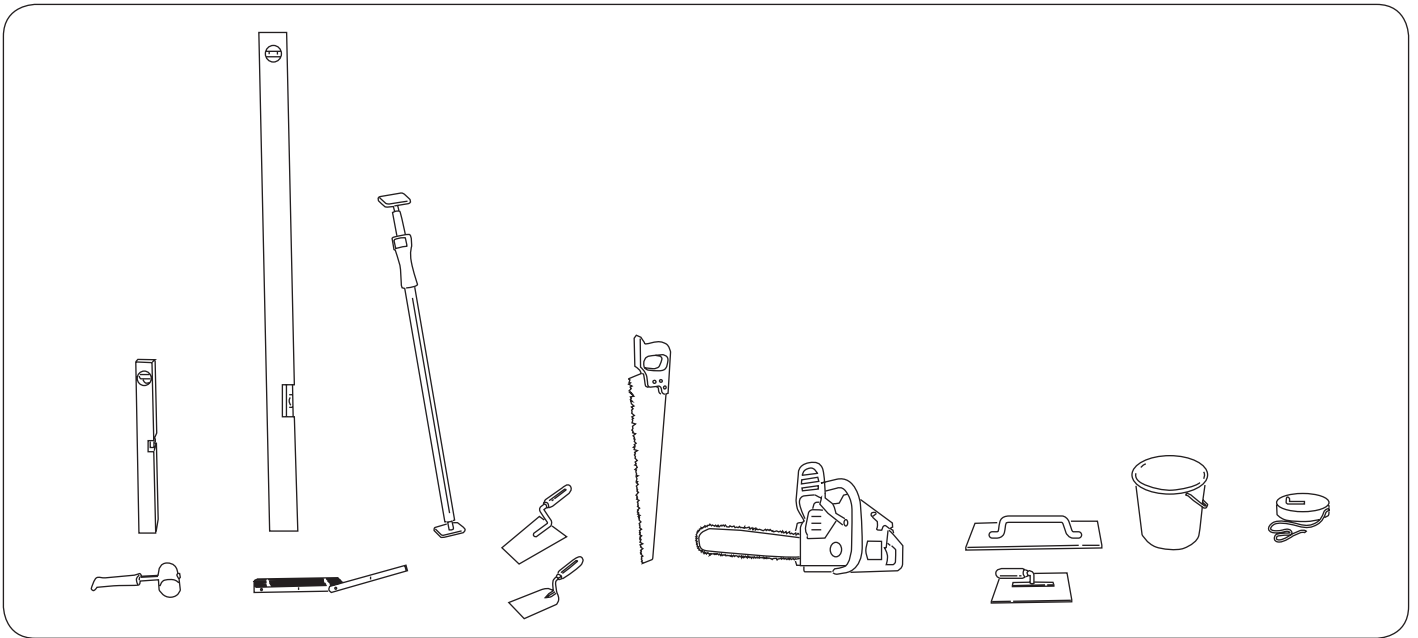

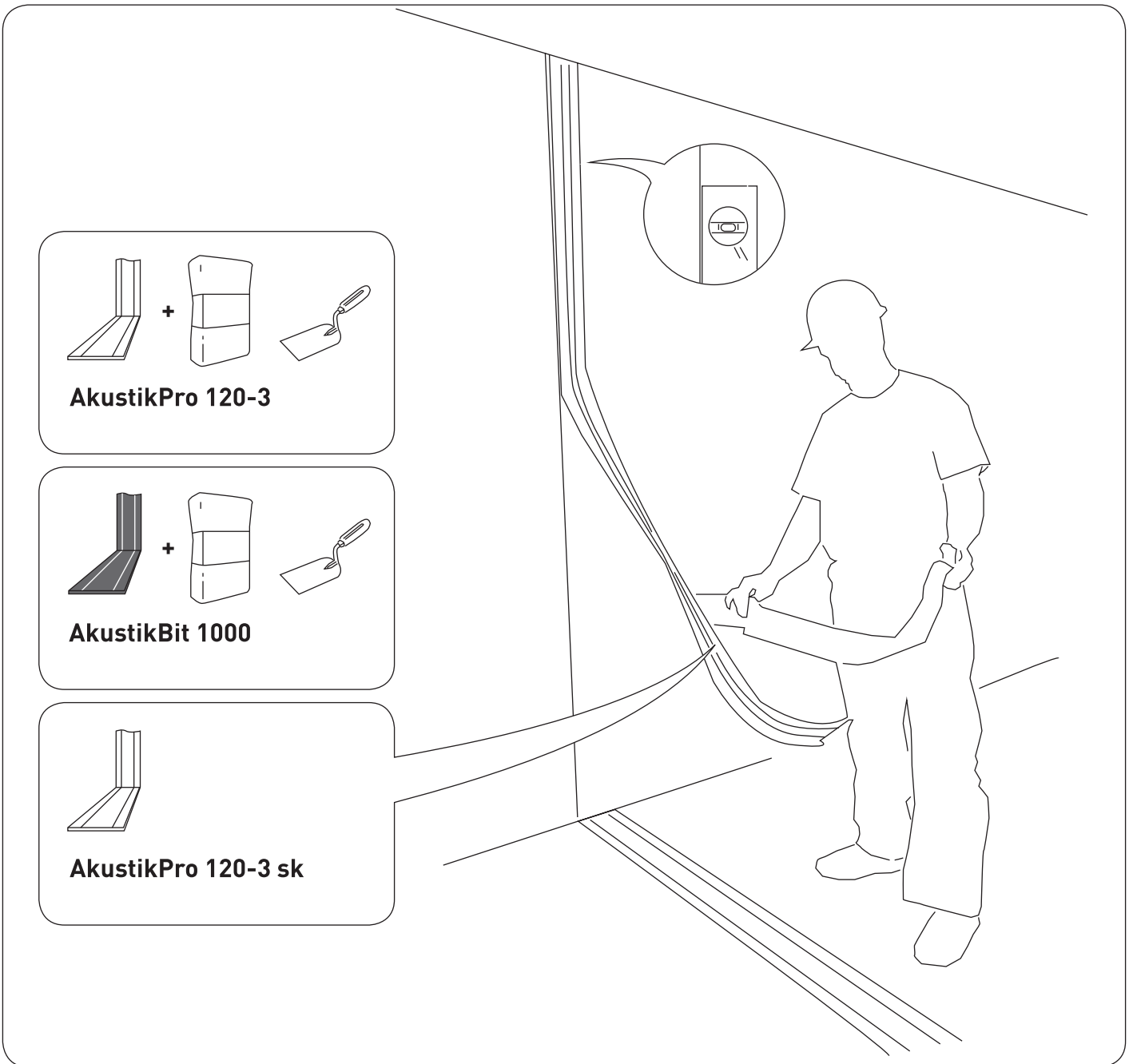
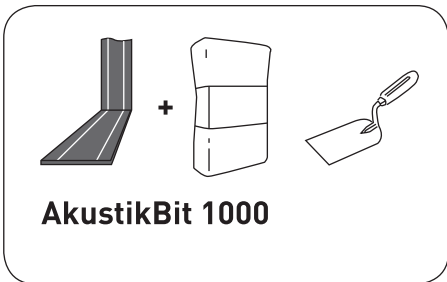
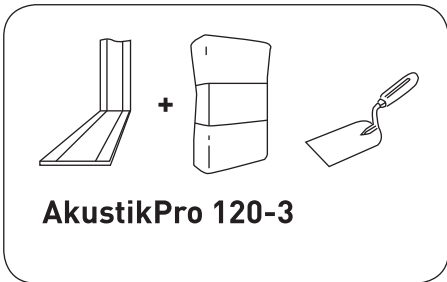
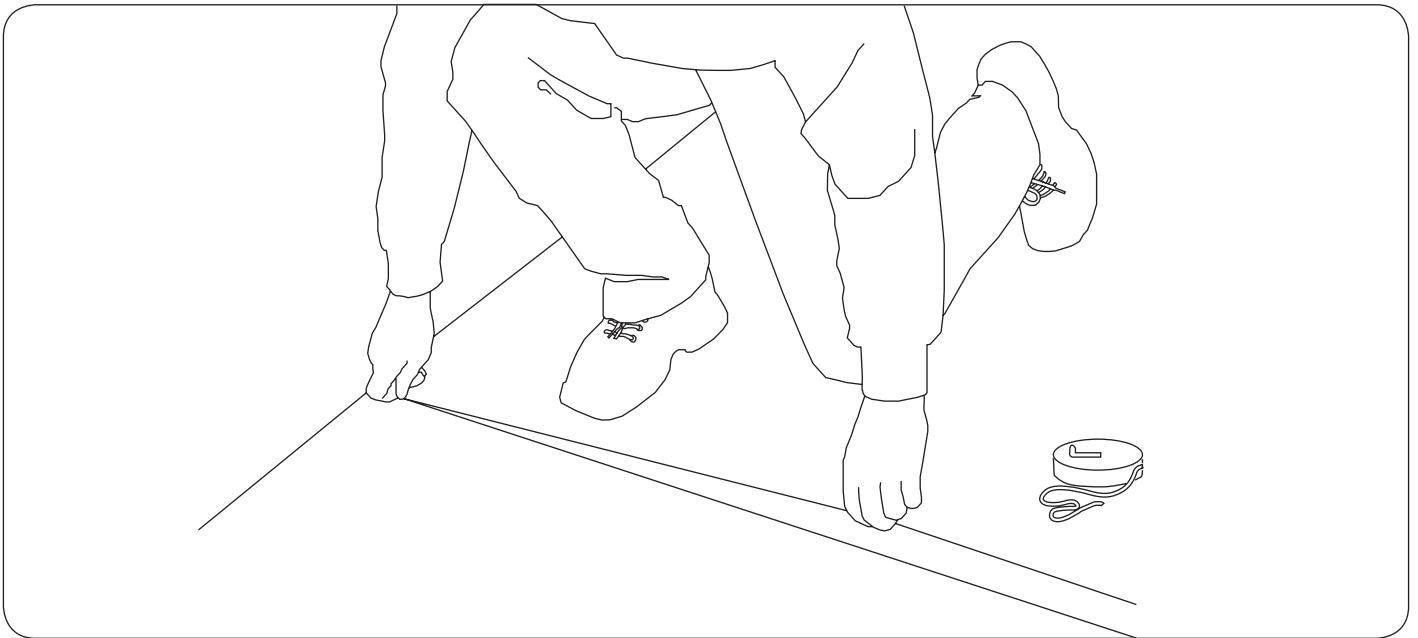

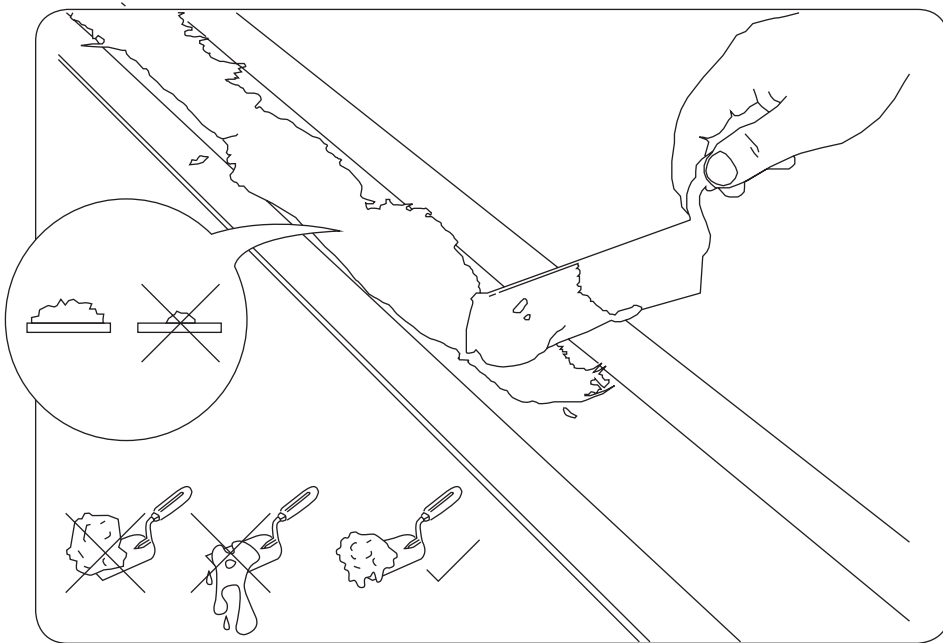

**Kleber
ClassicWeiss 90**



**Kleber
SuperWeiss 120/200**



**Kleber
Hydro 90**

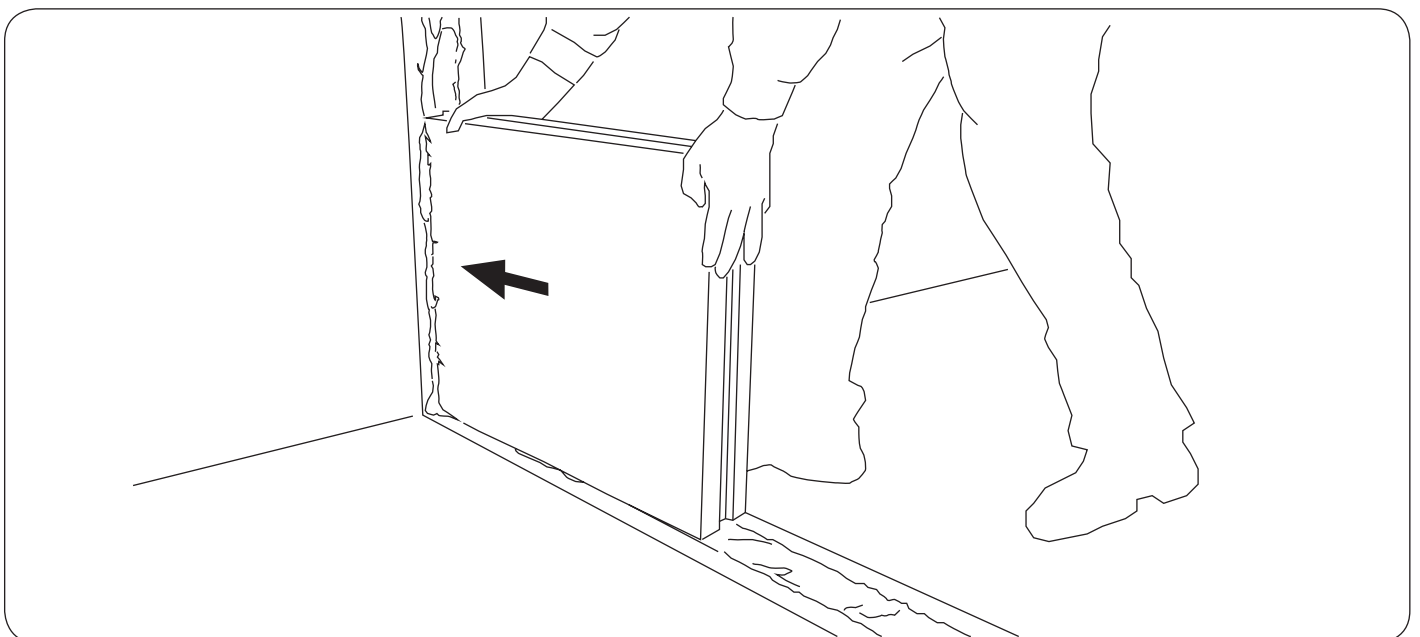
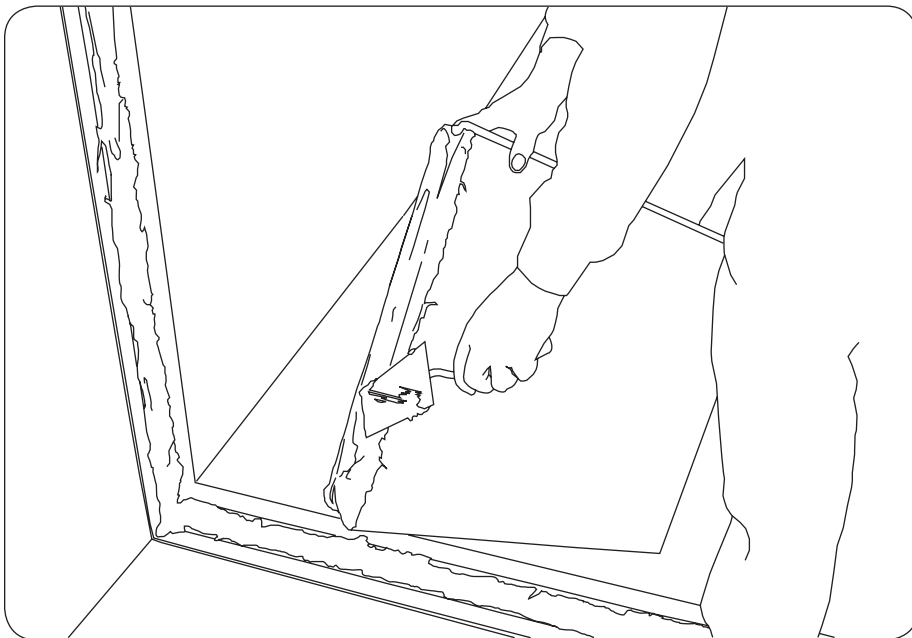
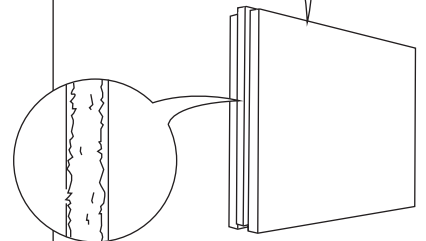
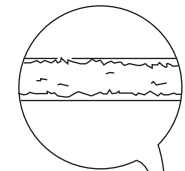

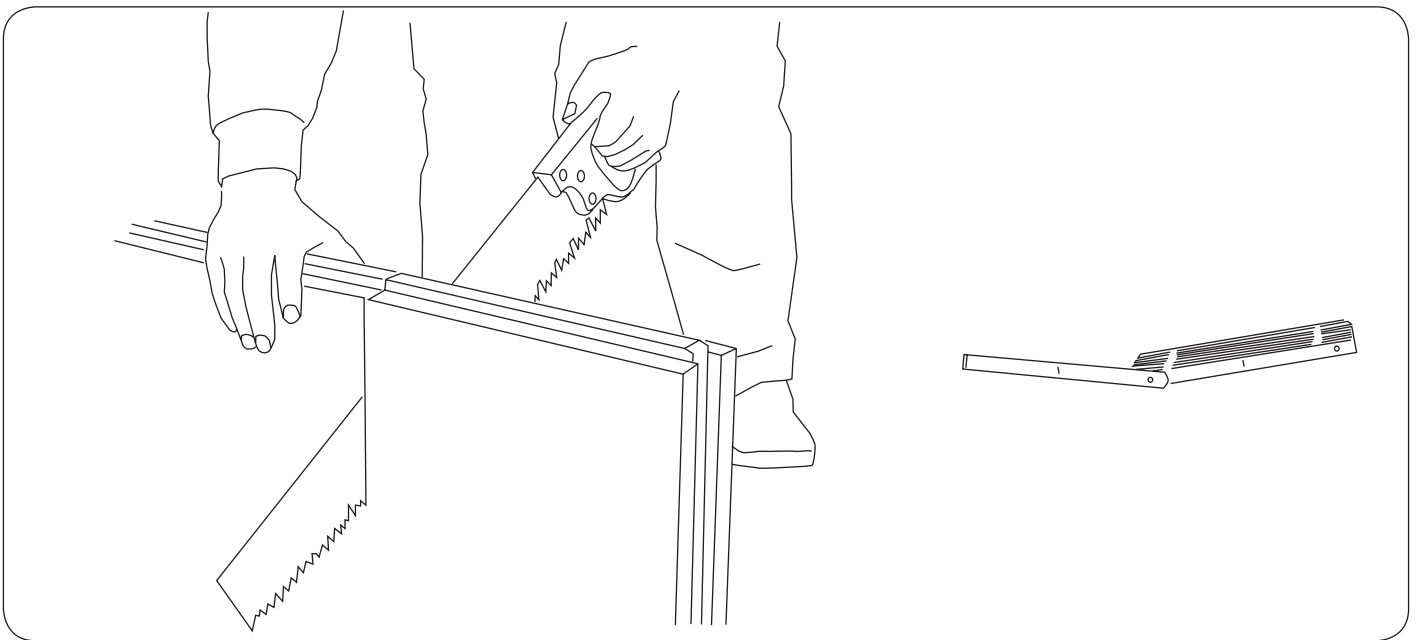
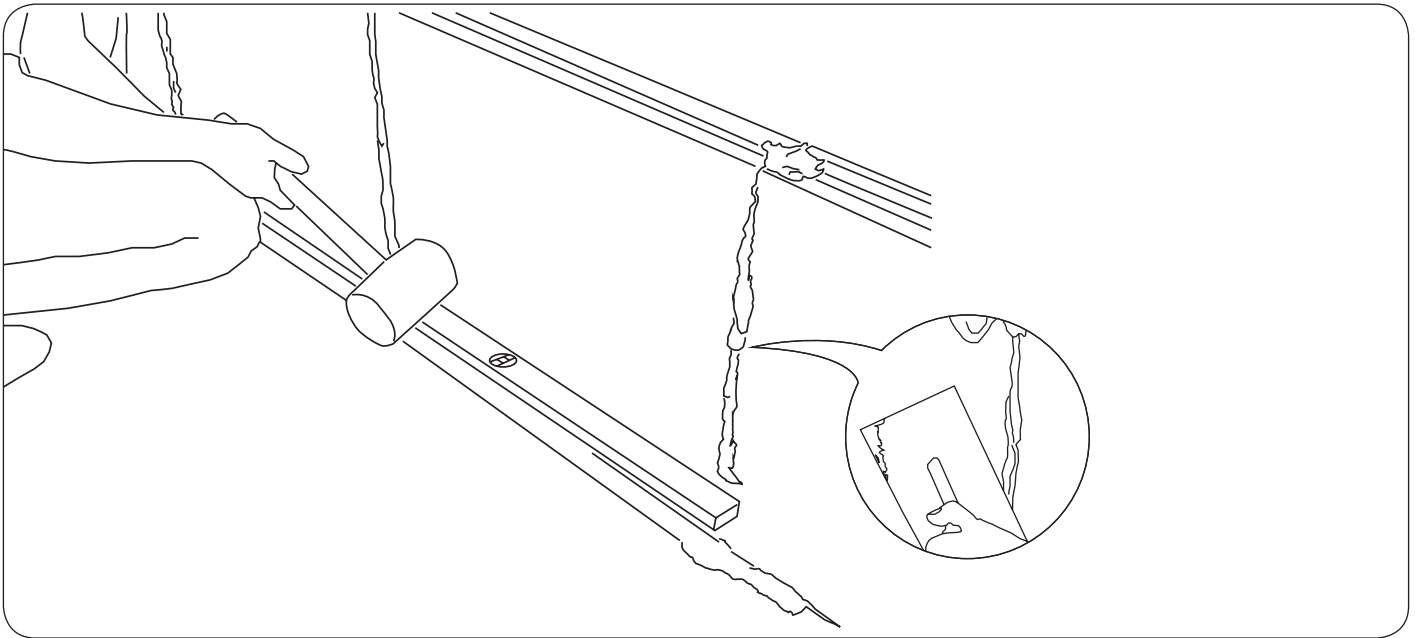
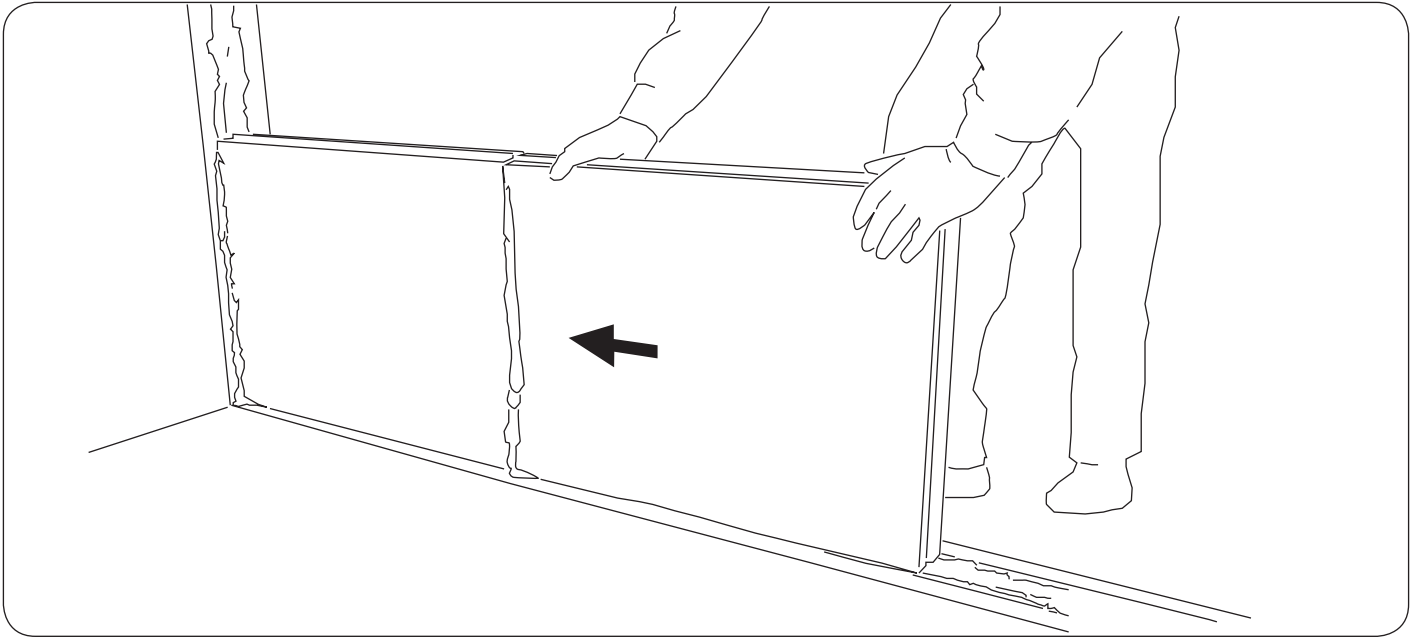

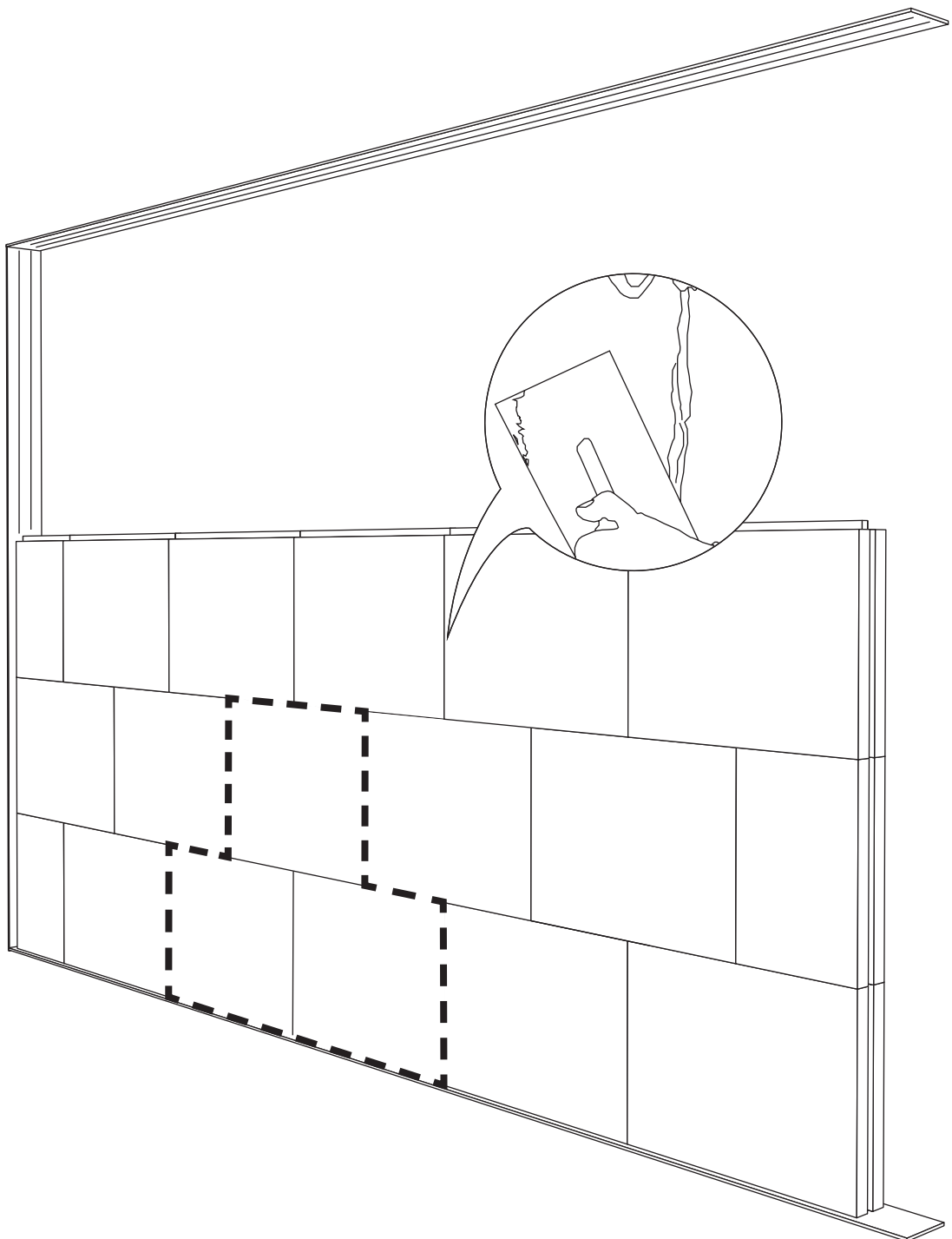

1 m²
666 x 500 mm
3 Platten

1 m²
500 x 500 mm
4 Platten

1 m²
400 x 500 mm
5 Platten

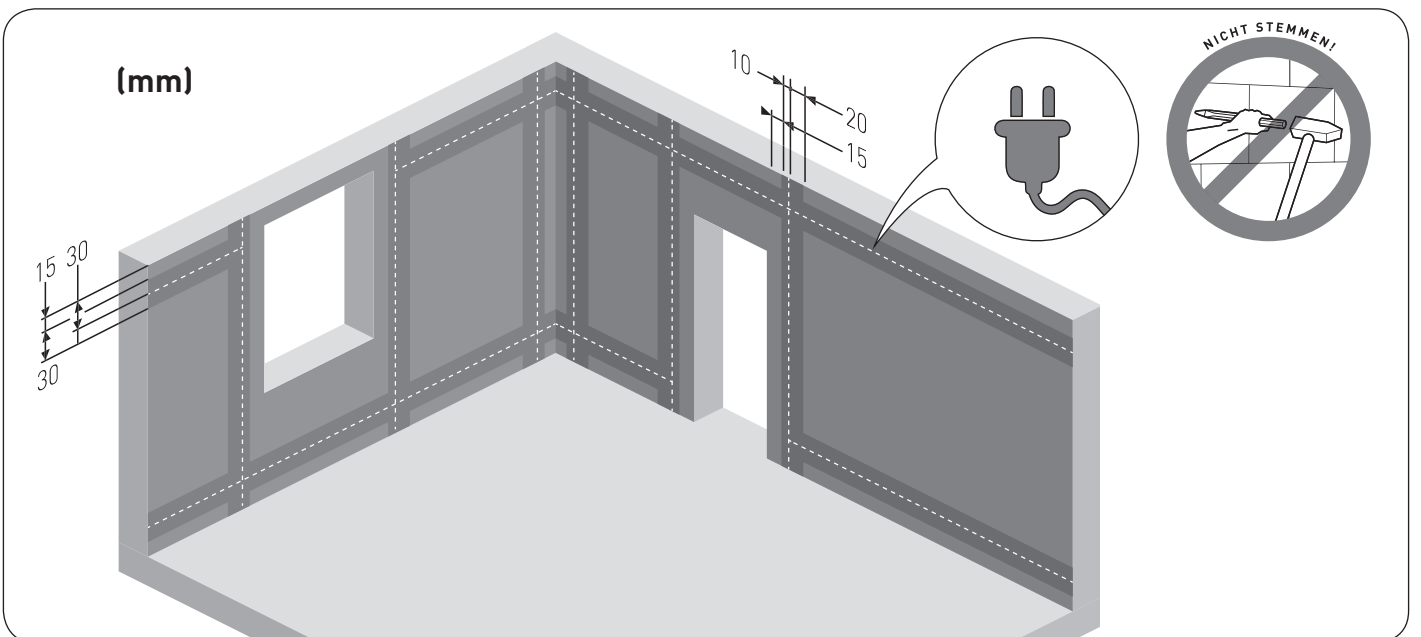
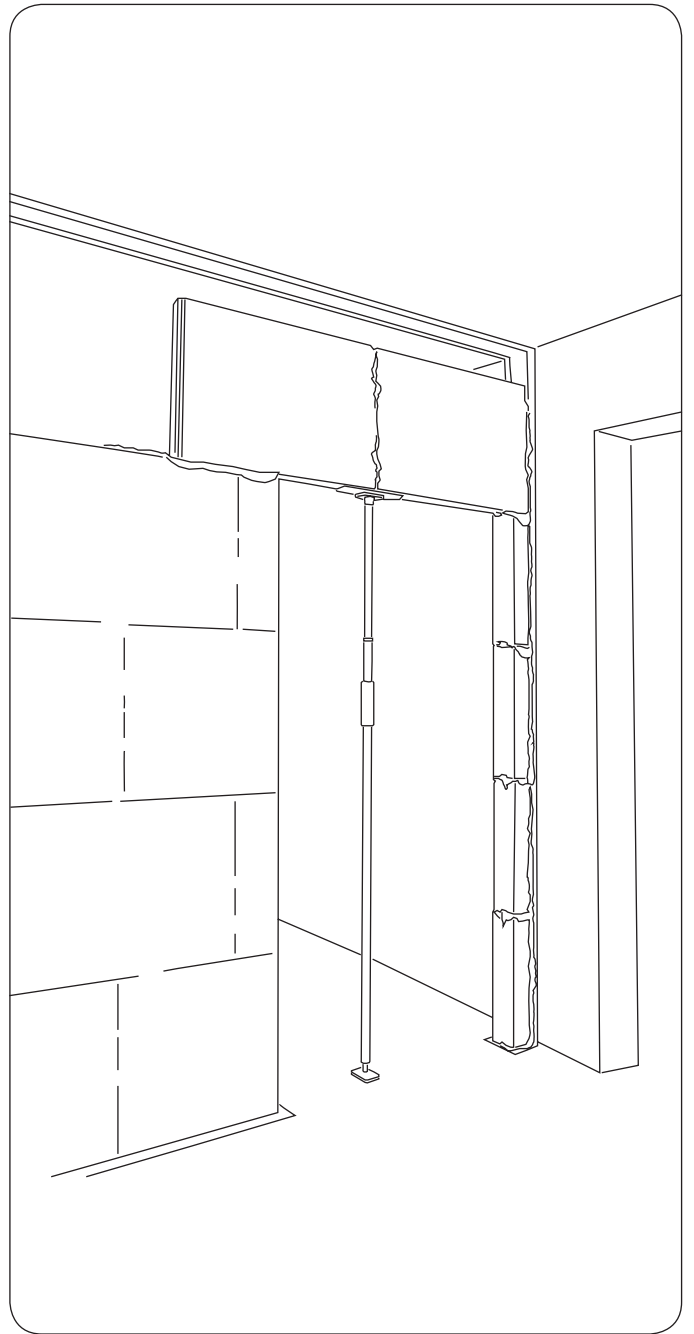
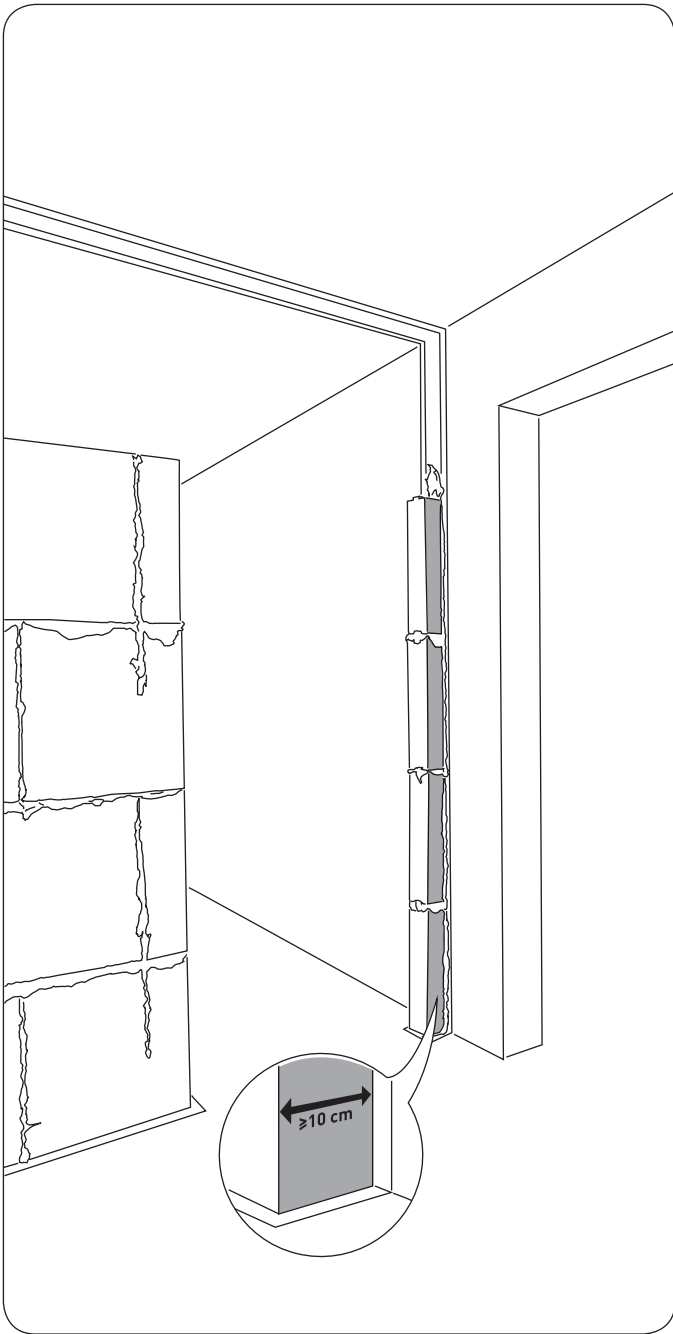

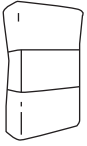

FG 70 Füll- und Zargengips

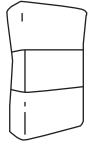

FG 700 Füllgips Spezial

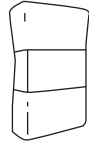

FG 70-B Füll- und Zargengips

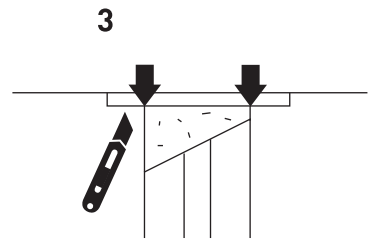
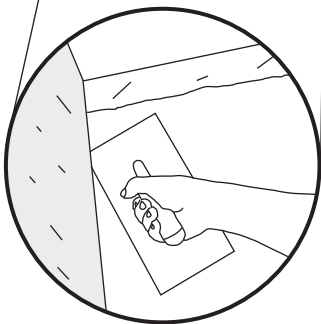
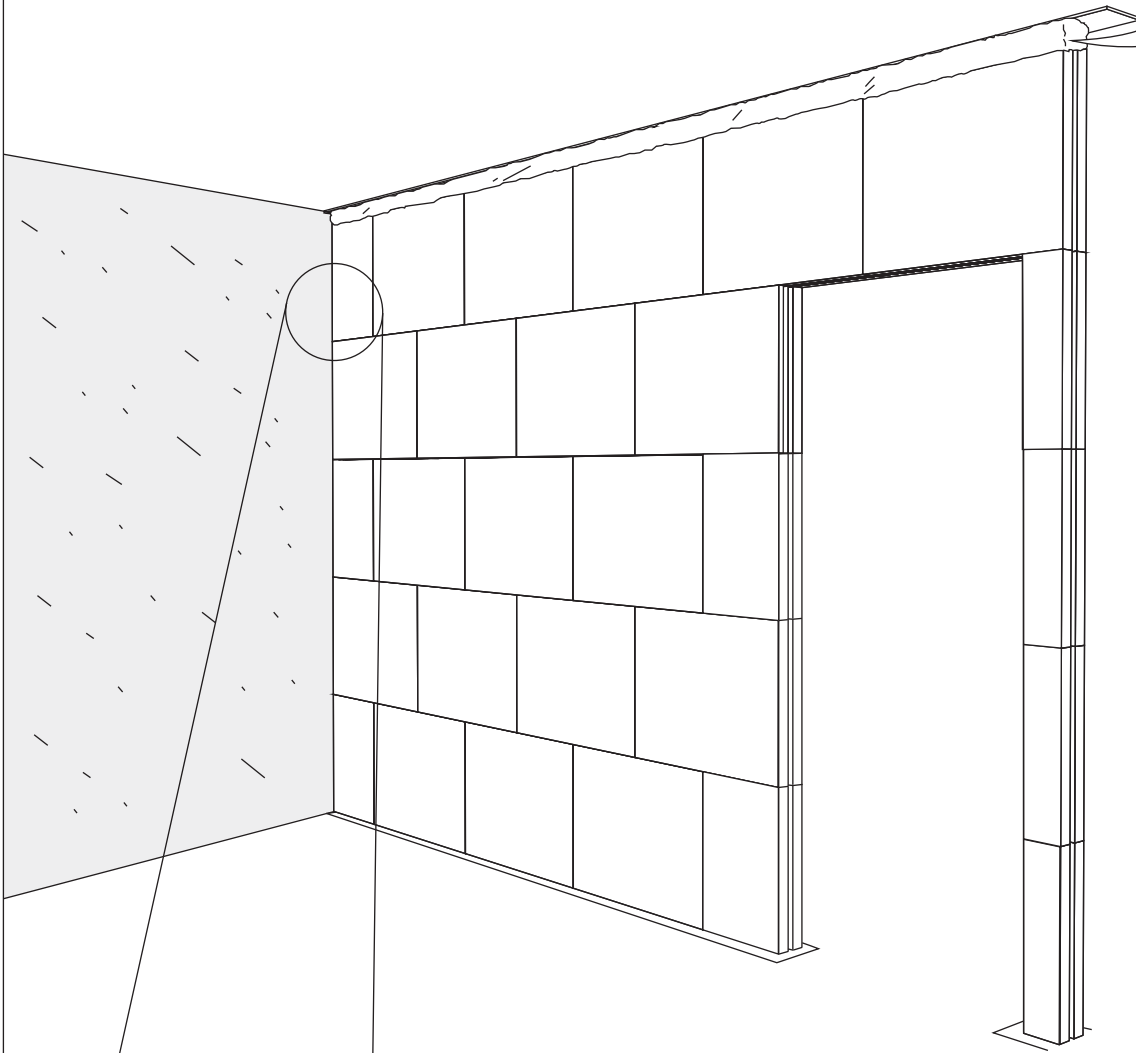
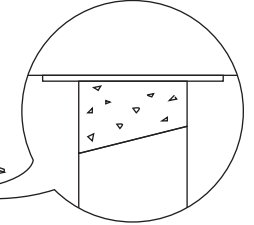
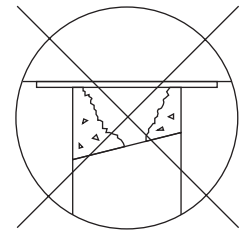

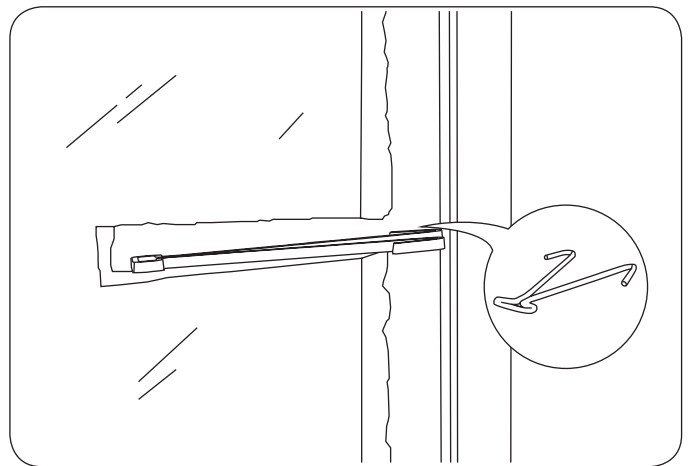
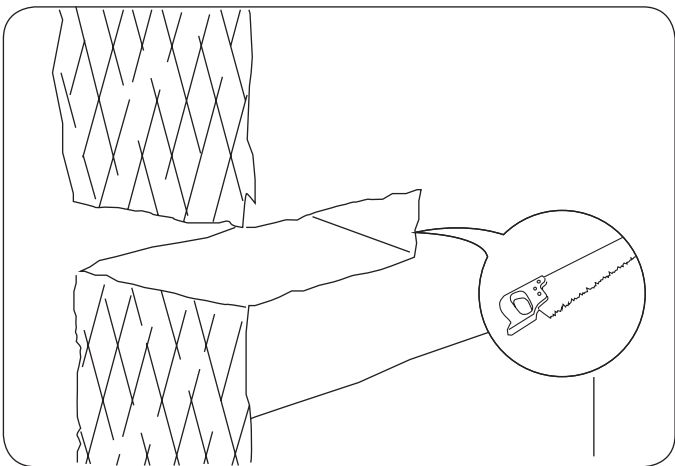
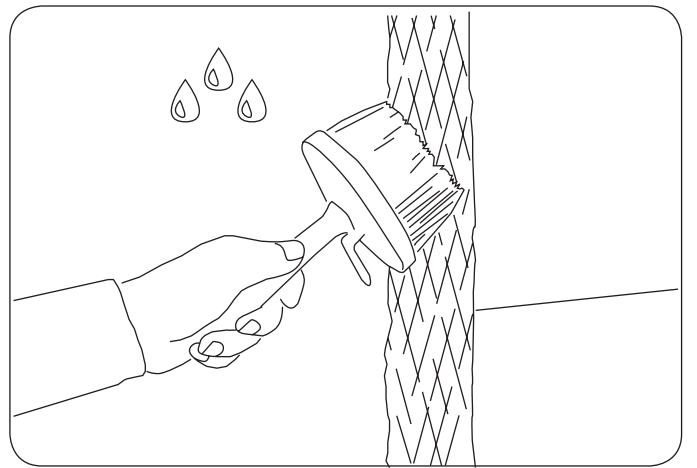
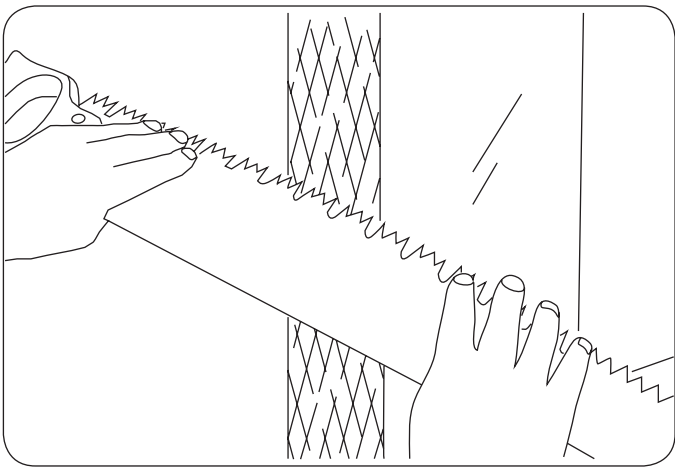
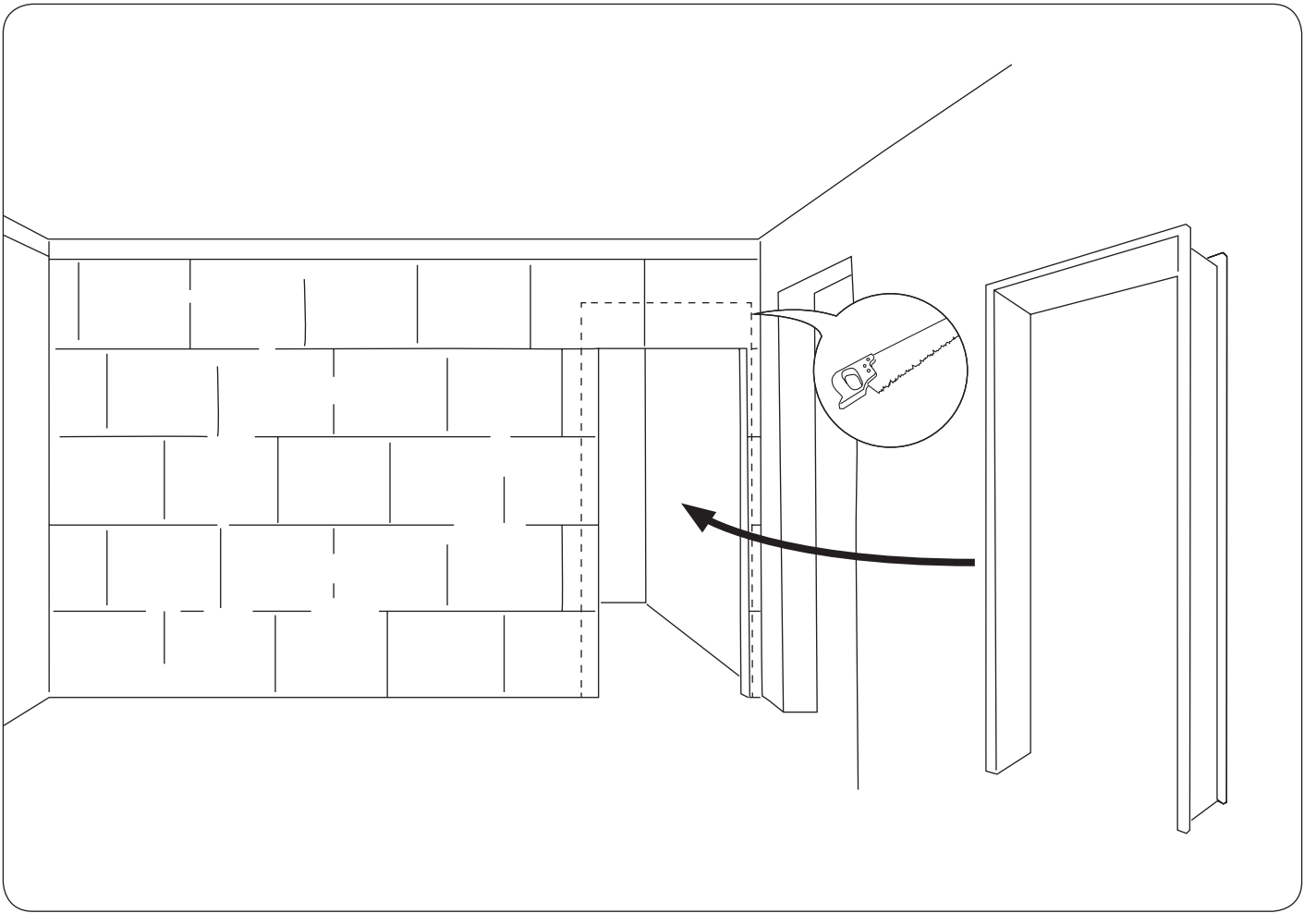

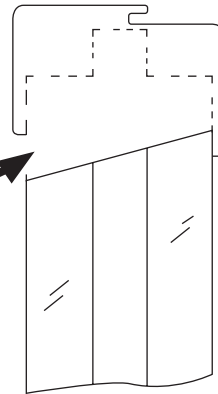
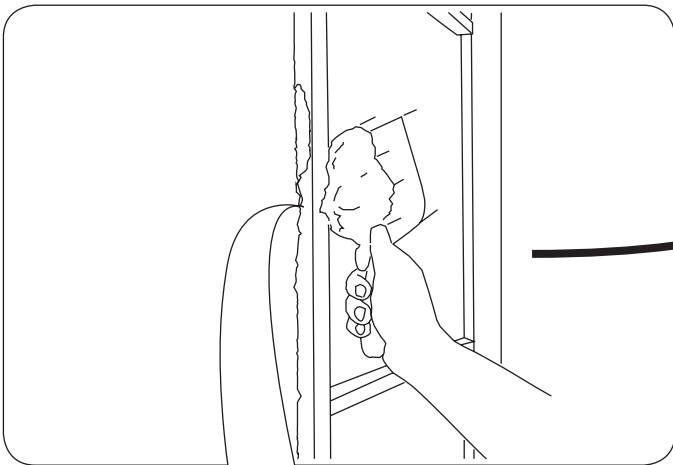
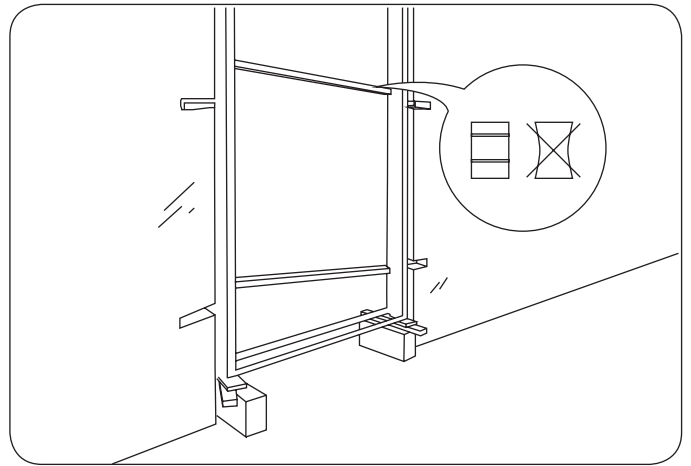
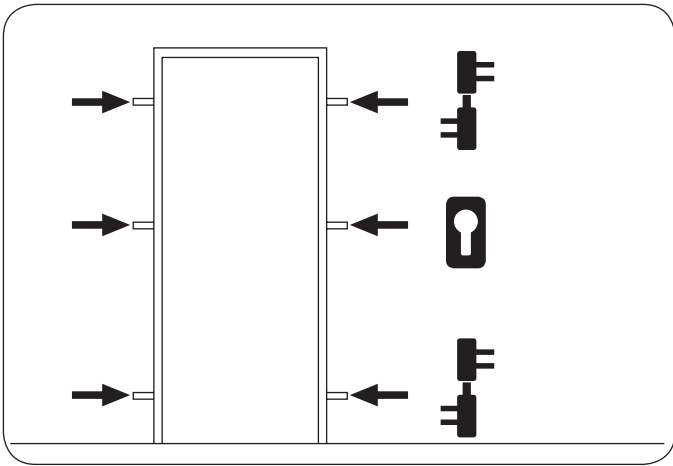

**FG 70/FG 700/
FG 70-B
Füll- und
Zargengips**

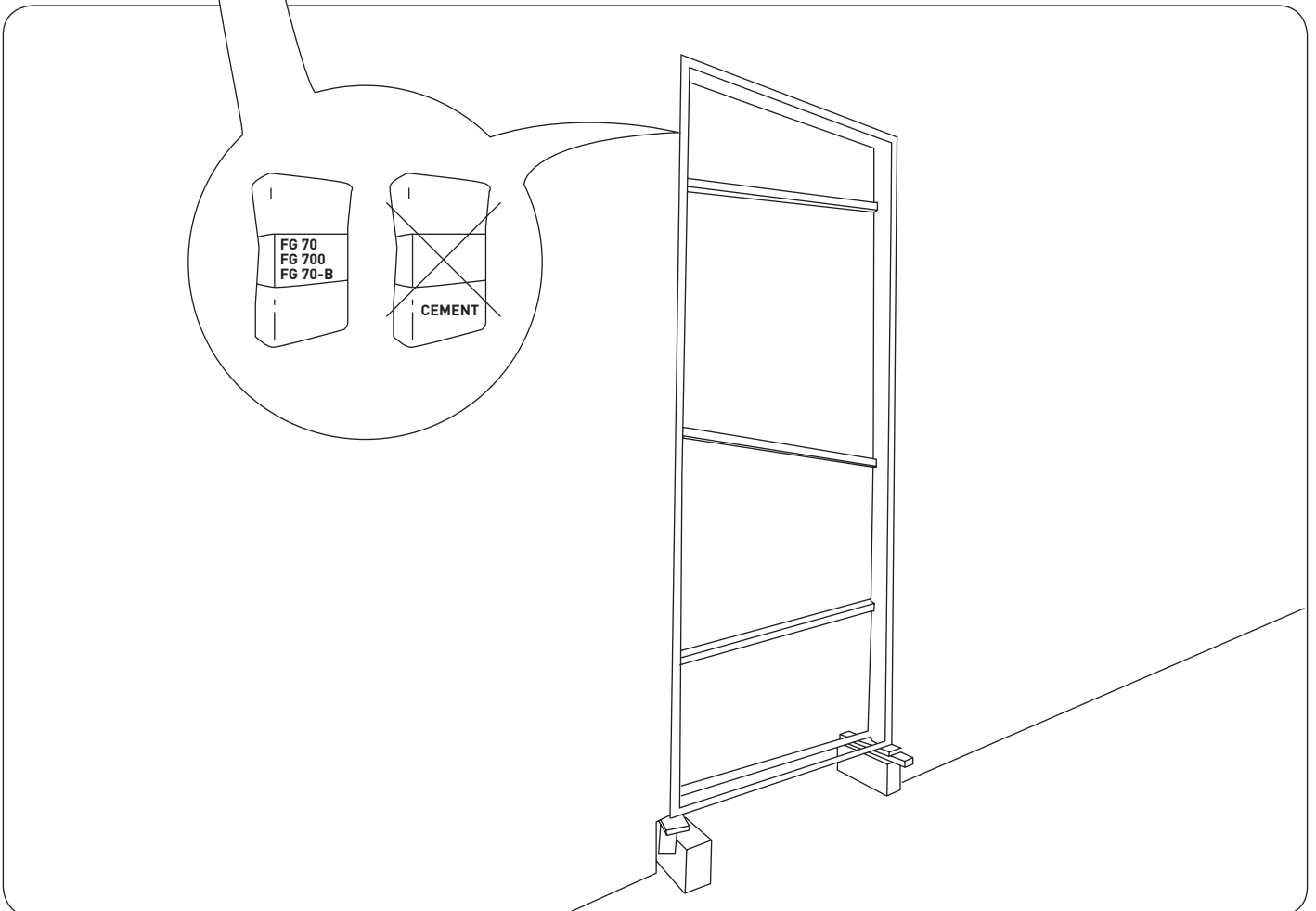

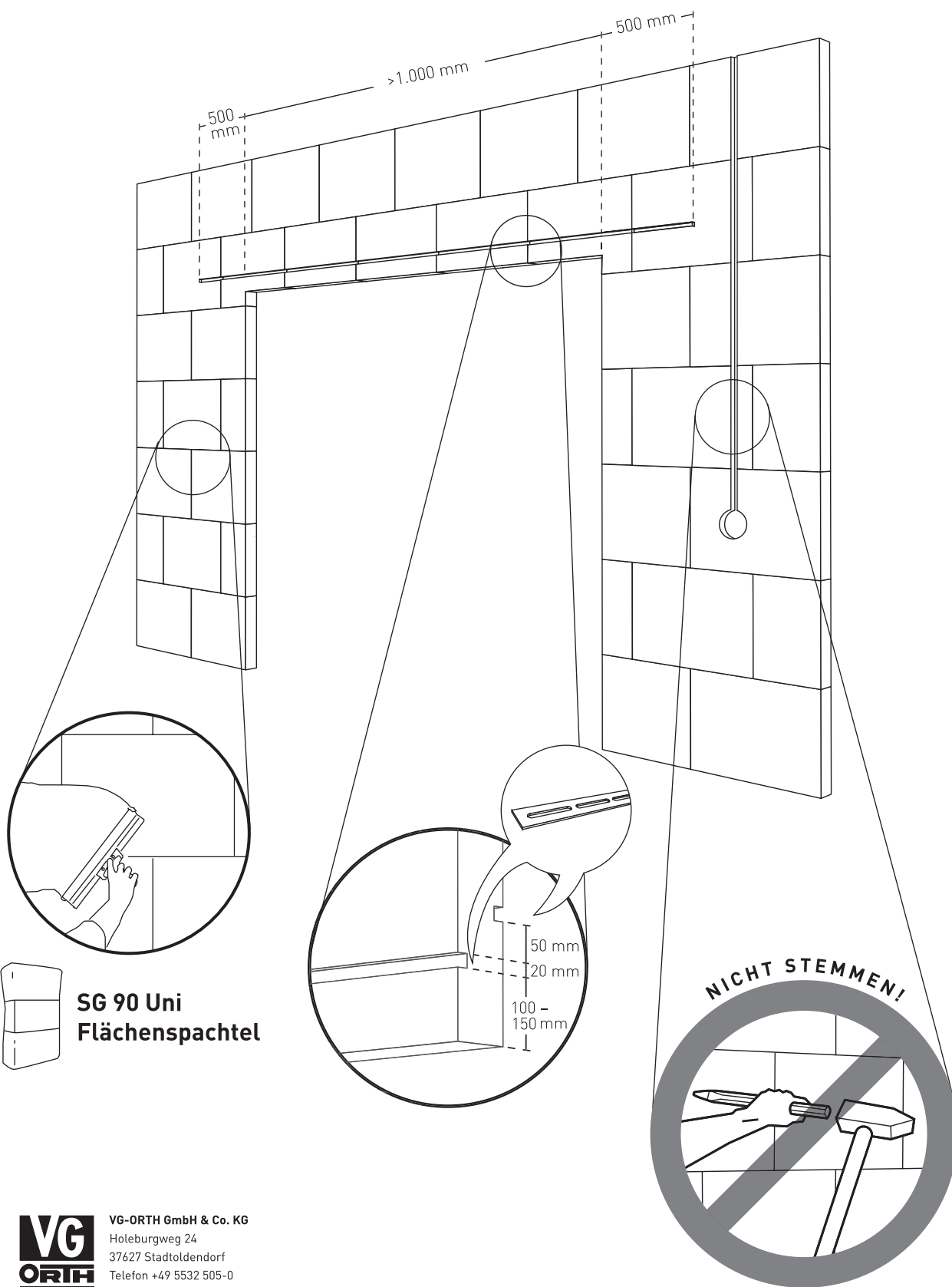

**SG 90 Uni
Flächenspachtel**



VG-ORIH GmbH & Co. KG
 Holeburgweg 24
 37627 Stadtoldendorf
 Telefon +49 5532 505-0
 Telefax +49 5532 505-560
 info@multigips.de
 www.multigips.de

Die technische Unterlage ist gültig ab Oktober 2020.

1. Aufl. 08.2013 (web, print), 2. akt. Aufl. 01.2014 (web, print), 3. akt. Aufl. 06.2015 (web, print),
 4. akt. Aufl. 07.2016 (web, print), 5. akt. Aufl. 10.2018 (web, print), 6. akt. Aufl. 10.2020 (web)